

# THE DIAPASON

DECEMBER, 1991



Arizona State University, Tempe, AZ  
Feature interview on page 12

# Silent Night

## The Night Was Silent (Christmas Eve 1990)

John E. Williams

Some 2½ years ago, I wrote a letter to the editor requesting that any Diapason readers who had or knew of material pertaining to the Christmas carol "Stille Nacht, heilige Nacht" contact me. The response was most gratifying. Since that time, I have sent quite a few items to the "Stille Nacht" Archiv in Hallein, Austria, and am still keeping an eye out for more items. Meanwhile, it became possible for me to spend last Christmas in Hallein where the curator of the Archiv, Herr Thomas Hochradner (a doctoral student in musicology at the University of Salzburg), took me to a number of "Stille Nacht" places, including Oberndorf, Arnsdorf, Salzburg, etc. I chose to stay at Hallein, as that is where the Archiv is and where Franz Gruber is buried. Also, the church in which the carol was first performed was destroyed many years ago, the present "chapel" being only a memorial. There follows a brief description of the "Memorial Hour" (there are also "Memorial Hours" in Oberndorf and Wagrain where Joseph Mohr is buried).

Darkness comes early in Austria in winter. By 4:00 p.m. the small square in front of the Stadtpfarkirche of Hallein was dark, as pilgrims of all ages began to appear, their way lighted through the streets and into the square by votive candles. The Christmas tree by the grave of Franz Xaver Gruber (the composer of "Silent Night") was covered with white lights, and the doorways of the school house across the small square where Gruber lived and taught were outlined with white lights. The grave was floodlit and two candles in red lanterns burned on the grave.

As the hour of 5:00 p.m. approached, a guard of honor was posted on either side of the grave, resplendent in their City Guards uniforms of black, red, white, and gold. One by one the peal

of eight bells in the church tower began to toll until the entire peal was sounding together—then the bells were silenced one by one. During the peal, the Halleiner Liedertal (a choral group) and a group from the Halleiner Buergergardemusik ("City guard music") under the direction of Josef Grabner took their place in front of the door of the Franz Xaver Gruber House (part of the school house).

As the bells were silenced, a brass quartet played from the second floor windows (the closest thing in the area to a tower which could be used) in which candles glowed red. Then in song, the spoken word, and the music of the brass quartet, "The Franz Xaver Gruber Memory Hour" took place. Most of the carols would not be known by Americans, but I recognized "Still, Still, Still" and "Lo, How A Rose E'er Blooming." Then came the moment everyone was here for. Amid silence so deep it was awe-striking, two men and a guitar appeared, and 3 stanzas of "Stille Nacht, Heilige Nacht" were performed in the original version, original key, with the choirs repeating the final two phrases of each stanza. No benediction or blessing was needed. God had been thanked and praised, and the crowd had been truly blessed.

Many went immediately into the church to view the Krippen (manger scene) while the bells of the church rang out once more. I and my new-found Austrian friend, after pictures at the grave, walked down hill on the cobblestones of the narrow main street, amidst the white lights of Christmas, in quiet fulfillment.

John E. Williams is Organist Emeritus at Laurinburg Presbyterian Church and Professor of Music Emeritus at St. Andrews Presbyterian College, Laurinburg, NC.

## Letters to the Editor

### Lessons and Carols

J. Bunker Clark's letter in the October, 1991 issue is particularly timely as we approach the Christmas season.

To those interested in the King's College service of lessons and carols, might I heartily recommend Stephen Cleobury's fascinating article which ap-

peared in the December, 1988 issue of *The Musical Times*? Apart from giving a fine history of the King's service, it contains much of great interest and makes for engrossing (and topical) reading, bedtime or otherwise.

Mark Buxton  
Toronto, Ont., Canada

## Here & There

Midwestern Historical Keyboard Society's 1992 annual meeting takes place April 30–May 3 at Eastern Illinois University, Charleston, IL. The program will include Larry Palmer in recital, "Music of the Harpsichord Revival"; Seth Carlin in a fortepiano Schubert recital; Edward Parmentier in a presentation on pre-Bach German harpsichord music; along with a performance of all of J.S. Bach's multiple-harpsichord concertos, instrument exhibits, a harpsichord care workshop, papers, festivities, etc. For information: MHKS, 251 Redondo Rd., Youngstown, OH 44504.

The 39th International Competition for Organ Improvisation Haarlem will take place July 7–11, 1992. Applicants submit recordings of improvisations on given themes. Ten contestants will be chosen to compete on the Christian Müller organ of the St. Bavo Church in two public preliminary rounds and the

finals. The winner will receive a monetary prize of Dfl. 7,500.—. Each of three other finalists will receive Dfl. 1,500.—. All contestants will receive accommodation expenses. For information: Stichting Internationaal Orgelconcours, P.O. Box 3333, 2001 DH Haarlem, The Netherlands; tel 023-160574, fax 023-160576.

The 4th International Organ Competition in Odense, Denmark, will take place August 13–21, under the patronage of His Royal Highness Prince Henrik of Denmark. The competition, which has been arranged by the City Magistrate of Odense, will be open for young organists under the age of 35 and of all nationalities.

The contest will consist of three rounds. Nineteen competitors can participate in the first round. Of these, ten will be selected for the second round, and five will be selected for the finals. The program includes standard reper-

# THE DIAPASON

A Scranton Gillette Publication

Eighty-second Year, No. 12, Whole No. 985  
Established in 1909

DECEMBER, 1991  
ISSN 0012-2378

An International Monthly Devoted to the Organ, the Harpsichord and Church Music  
Official Journal of the International Society for Organ History and Preservation

## CONTENTS

### FEATURES

- Silent Night: The night was silent by John E. Williams 2
- Organ Design based on registration by Robert Noehren 10
- Cover: Paul Fritts—An organ builder who "walks the line" between antique and modern by Herbert L. Huestis 12
- Dyer organ for Union College by W. G. Marigold 15

### LETTERS TO THE EDITOR

### NEWS

- Here & There 2, 3, 4
- Appointments 3
- Carillon News by Brian Swager 6

### REVIEWS

- Music for Voices and Organ 6
- New Recordings 7
- Vocal Solos 8
- New Organ Music 8

### NEW ORGANS

### CALENDAR

### ORGAN RECITALS

### CLASSIFIED ADVERTISING

Editor

JEROME BUTERA

Associate Editor

WESLEY VOS

Contributing Editors

LARRY PALMER  
Harpsichord

JAMES McCRAY  
Choral Music

HERBERT L. HUESTIS  
IN-Group Forum

BRIAN SWAGER  
Carillon

Subscribers: Send subscriptions, inquiries and address changes to THE DIAPASON, 380 Northwest Highway, Des Plaines, IL 60016. Give old and new addresses, including zip codes. Enclose address label from last issue and allow four weeks for change to become effective.

No portion of the contents of this issue may be reproduced in any form without the specific written permission of the Editor, except that libraries are authorized to make photocopies of the material contained herein for the purpose of course reserve reading at the rate of one copy for every fifteen students. Such copies may be reused for other courses or for the same course offered subsequently.

toire and one recent Danish work.

The city of Odense has offered three prizes: first prize of Dkr. 20,000, second Dkr. 15,000, and third Dkr. 10,000. In connection with the prizes, organ pipes with inscription will be handed out. The fourth and fifth finalists will also receive inscribed organ pipes, donated by Marcussen and Son, Aabenraa.

The opening concert will take place in Odense Concert Hall with the Odense Symphony Orchestra and with one of the jury members as soloist. The first round will take place on the 56-stop Marcussen organ in Odense Cathedral; the second round on the 37-stop Marcussen at St. Hans Church; and the finals on the 46-stop Marcussen in Odense Concert Hall. During the week, six organ concerts are planned with members of the jury as soloists: Martin Haselböck, Grethe Krogh, Susan Landale, Jon Laukvik, Jacques van Oortmerssen, Simon Preston, and Anders Riber.

Application deadline is April 1. For information: Secretariat, The 4th International Organ Competition, Laessøgade 74, DK-5230 Odense M, Denmark.

The 1992 Sidney R. Case Competition for Young Organists, which is intended to encourage study in liturgical organ-playing and provide experience in open competition, is announced by St. John's Episcopal Church in Beverly Farms, MA. Applicants must be currently enrolled in a high school or college, and may not have participated in any open competition. Organ majors

must not anticipate graduation from undergraduate studies earlier than May, 1994—all other undergraduate or high school students are encouraged to apply. There is no age limitation. The first prize is \$500; runner-up \$250. The repertoire requirements are a slow (middle) movement from a Bach Trio Sonata and one other piece of the contestant's choosing, with the total playing time not to exceed twelve minutes. The sight-reading of a hymn is also required. The competition will take place on Saturday, May 2, 1992. Applications must be received by April 6, and are available from Mark Dirksen, Director of Music, St. John's Episcopal Church, P.O. Box 5610, Beverly Farms, MA 01915; 508/927-0229.

The service of Advent Lessons and Carols at the Episcopal Cathedral of St. Philip Atlanta, GA on December 8 was recorded for syndication by the American Public Radio. The service was recorded and produced by local station WABE, in cooperation with KUSC of Los Angeles, and syndicated by the American Public Radio as part of a four-part series to be sent to 400 affiliated stations this month.

The Iowa City Early Keyboard Society, continuing its tradition of presenting historically authentic musical performances in eastern Iowa, is presenting its seventh annual Early Music Iowa Subscription Concert Series. The series opened October 20 with harpsichordist Eiji Hashimoto, a native of Japan currently harpsichordist-in-resi-

dence at the University of Cincinnati's College-Conservatory of Music. In addition to several recordings, he has to his credit several urtext editions of 18th-century keyboard music.

Fortepiano and Beethoven specialist Kenneth Drake performed on November 24. He is currently a member of the piano faculty at the University of Illinois, Urbana. Drake performed on his original Broadwood fortepiano built in 1816.

Concluding the series on March 1 will be San Francisco harpsichordist Katherine Roberts Perl. She has served on the faculty of the San Francisco Early Music Society Summer Baroque Workshops and the San Francisco Conservatory of Music.

The series takes place at Preucil School of Music, Iowa City. For information: John Fix, Early Music Iowa, 4 Ashwood Drive, Iowa City, IA 52245.



Methuen Memorial Music Hall

The Methuen Memorial Music Hall in Methuen, MA, presented a series of eighteen weekly organ recitals during 1991, its forty-sixth season. Extending from June 5 through October 2, the series included organists from across the country as well as from Switzerland, England and Latvia. The recitalists were Hannes Meyer, Bruce Neswick, Paul Jenkins, Brian Swager, Ann Labounsky, Andrew Fletcher, Glenn Goda, Margaret Scharf, Charles Krigbaum, Adrienne M. Pavur, John Gouwens, Frederick Hohman, Margaret Irwin-Brandon, Frederick Jodry, Renea Waligora, Timothy Hughes, Kenneth Starr and Aivar Kalejs. Music Hall Board of Trustees President Edward Sampson reported a total series attendance of over 3,300, a 10 percent increase relative to the previous year.

## Appointments



Richard Anderson

Richard Anderson has joined Rodgers Organ Sales of Hillsboro, OR, as sales manager responsible for pipe organ, electronic organ and keyboard sales to churches and homes in northern Oregon and southwest Washington. Previously Anderson spent 16 years with Rodgers Organ Company, later

Rodgers Instrument Corporation, Hillsboro, in various marketing and sales positions including 4½ years as Rodgers' director of marketing. Rodgers Organ Sales represents Rodgers Classic Organs, Rodgers Classic Keyboards, and pipe organs in Oregon and Washington. The Rodgers dealership is owned by Patrick and Dianne Phaneuf of Beaver-ton, OR.



David Burton Brown

David Burton Brown has been named Director of Music Ministries at St. James Episcopal Church, Birmingham, MI. Dr. Brown assumed this position following a 41-year tenure of former organist/choirmaster, Kent McDonald.

David Brown has served parishes in Pennsylvania, Indiana, New Jersey, Tennessee, and Germany, and most recently was Interim Organist/Choirmaster of First Presbyterian Church, Philadelphia. He will be responsible for all organ playing at St. James, three of the four parish choirs, and a concert series.

Brown was educated at Westminster Choir College, Princeton, NJ, and Indiana University, Bloomington, IN, and has recently completed a year's sabbatical in Hamburg, Germany where he studied organ with Heinz Wunderlich and conducting with Roland Voigtlander. While in Germany he was Kirchenmusiker (organist/choirmaster) of Emmauskirchengemeinde in Hamburg, and played many recitals in Germany, Denmark and England.

St. James has a well-established ministry through music, with an RSCM-affiliated graded-choir program, a professional parish choir, and special musical events through the church year.



Barbara Harbach

Barbara Harbach has been appointed Professor of Music at Washington State University, Pullman, WA, where she will teach organ and harpsichord, performance practice, and music theory. Harbach is a graduate of Penn State, Yale, and the Eastman School of Music. A specialist in contemporary organ and harpsichord music, she has recorded compact discs with Gasparo Records, Kingdom Records, and Albany Records. She is also involved in the research, publication, and recording of

music by women composers, especially from the 18th century. An active composer, Harbach has written over 100 choral anthems and keyboard works. Harbach records and performs throughout the country, with upcoming performances at the Redlands Organ Festival and the AGO National Convention in Atlanta.

Dr. Harbach also assumes responsibilities as Organist and Director of Music at Trinity Lutheran Church in Pullman where she will conduct the adult and youth choirs.

## Here & There

Gerald Bales' *Elegy for Trumpet and Organ* was given its Canadian premiere by organist Paul Merritt and trumpeter Larry Larson at First-St. Andrew's United Church, London, Ont., September 29. *Elegy* was commissioned by Richard Proulx and Larry Larson, who together played its world premiere in Chicago in January, 1991.

Bales' *Eclat for Large Orchestra* was performed at the University of Western Ontario (London, Ont.) October 26. The University Symphony Orchestra was conducted by Jerome Summers.



Diane Meredith Belcher

Diane Meredith Belcher played her 1990-91 season in a "great way:" her recitals in Atlanta, Carbondale, IL, Chicago, Memphis, Greenville, SC, Little Rock, and Minneapolis were all played while "great with child." The 10-lb. bruiser, James MacGregor Ayer, arrived on May 27 to proud parents Diane and John Ayer. Ms. Belcher also managed to accompany and sing in Ayer's new Pro Organo release with the Memphis Boychoir (*What Sweeter Music*), recorded just one month before the birth. This season baby James will be traveling to Clarksville, AR; Chattanooga; Ursinus College, PA; Jacksonville, FL; Washington, DC; Columbus, OH; Akron, OH; Newark, NJ; and Charleston, WV, for his mother's recitals. Inquiries for the 1992-93 season should be addressed to Julie Lang, personal manager, 340 S. Reese, Memphis, TN 38111; 901/327-2417.

This past fall, Delores Bruch, professor and chair of the organ department at the University of Iowa, continued her involvement with historic organs. September 9 she played a program of solo and chamber music by Mozart at Zion Lutheran Church, Iowa City; organ by George Stevens (1853), renovated and rebuilt by A. David Moore (1976). On September 15, Dr. Bruch played music of Franck on the 1883 Moline organ at St. Mary's Catholic Church, Iowa City. The organ is the only extant 3-manual instrument by Moline, and was restored by Michael Quimby. October 20, she played the dedicatory concert on an early 20th-century Felgemaker, which was refurbished and moved to St. Wenceslaus Catholic Church, Iowa City, by Quimby Pipe Organs. And November 17, Bruch

played the dedicatory concert at Unitarian Universalist Society, Iowa City; organ by Felgemaker (1908), refurbished by John Bixler and Vince Gilbert. In addition, Dr. Bruch chaired a panel on September 22 at the centennial celebration of the Schuelke organ (1891) in St. Boniface Catholic Church, New Vienna, IA.

Volume II of *Pulling Out All the Stops* is now available. Written and illustrated by Catherine Fischer, the book is a "humorous look at the pipe organ." \$5.50 from C. Fischer, P.O. Box 9051, Pittsburgh, PA 15224.

Bainbridge Records has announced the release of *The Christmas Album* by the late Virgil Fox. This original Command Records Classic was recorded at the Church of St. Paul the Apostle in Manhattan in 1965, and includes *The First Noel*, *In dulci jubilo*, *I wonder as I wonder*, *The Virgin's slumber song*, *Vers la creche*, *I saw three ships*, *God rest ye merry, gentlemen*, *Divinum Mysterium*, *O holy night* and *Variations on 'Adeste fideles'*. For information: Bainbridge Records, P.O. Box 8248, Van Nuys, CA 91409-8248; 213/476-0631.



Michael Gailit

Michael Gailit of Vienna, Austria, makes his sixth tour to the United States in January/February 1992. During the tour, he will perform again the complete piano and organ works by Julius Reubke in one program (*Mazurka*, *Scherzo* and *Sonata* for piano; *Trio* and *Sonata* for organ), this time at the Sixth International Organ Festival at the University of Redlands, CA (January 20-22). On this occasion, he will also give a lecture on Reubke and the structure of Reubke's organ sonata, the *94th Psalm*. Gailit's tour also includes appearances with music by J.S. Bach, F. Schmidt and F. Liszt at Pittsburgh Cathedral, PA (February 4) and Baylor University, Waco, TX (February 11). A member of the faculty of the Vienna Academy of Music, Gailit has performed in the U.S. since 1984 and is represented by Concert Artist Cooperative.

David A. Gell marked his 30th anniversary year as a church musician with a recital of Dutch organ music on November 3 at Trinity Episcopal Church, Santa Barbara, CA. The Santa Barbara Boys Choir sang the service of Evensong following the recital. Born in Calgary, Alberta, Canada, Mr. Gell moved to southern California, where he began studying organ at the age of 14. He continued studies at Azusa Pacific University, New Orleans Baptist Theological Seminary, the University of Hawaii and the University of California at Santa Barbara. The anniversary recital included music of Sweelinck, Van Noordt, Kee, and Zwart.

Compositions of James McCray were featured in a faculty recital at Colorado State University October 8. Works included *Cold Blows the Wind*, *Laudate Dominum*, *Sonne of God*, *Unto Thee*, *Winds Through the Olive Trees*, *Love Is*, *Nocturne in a Deserted Brickyard*, *Set*

*Me As a Seal, I Was Glad, There is No Rose, Nowell, Nowell, A Child Said, and A Jubilant Song.* Performers included Colorado State University's Women's Choir, John Lueck, director; Hope Mitchell, flute; Stephanie Bennett, piano; Janine Ross, conductor; Lisa Bryan, piano; June Bowser, soprano; James McCray, piano; Virginia Runyan, mezzo-soprano; Girls' 21 of Cherry Creek High School, Charlotte Adams, director, Nancy Diel, accompanist; and Allison Russell, oboe.



Former students of Emmet Smith at 40th anniversary celebration

performed on the 110-rank Aeolian-Skinner organ at the RLDS Auditorium in Independence, MO. The recordings are available from Herald House 1-800/767-8181, and Gothic Records 1-800/735-4720.

On October 7 and 8, many former students and friends of **Emmet G. Smith** gathered on the campus of Texas Christian University in Fort Worth, TX, to celebrate the beginning of Mr. Smith's 41st year as instructor of organ at TCU. Smith now holds titles of Professor of Organ and Church Music, University Organist, as well as the distinguished chair as Herndon Professor of Music at TCU.

Emmet Smith began teaching organ at TCU in 1951. He has taught hundreds of students during the past four decades and holds the distinction of having had 12 students win Fulbright awards for study abroad, in addition to numerous other international scholarship winners amongst his students.

More than 90 former students attended this two-day celebration, coming from all parts of the United States and from Canada. Smith was presented with a computer, as well as an original, commissioned calligraphic work of art, and given a scrapbook of memorabilia sent by students and friends. The picture was taken around the organ console in TCU's Ed Landreth Hall, and includes some of the former students with their teacher.

Organizers of the event were Betty Boles, Larry Peterson, and Mark Scott.

**Michael Stairs** is featured on a new CD recording, *A Longwood Gardens Christmas*, Longwood Gardens Organ, volume 3. The disc includes 19 carols, sacred and secular, played on the 1930 Aeolian/1958 Moller organ at the Longwood Gardens. DTR9102CD. Available from DTR Co., 14 Station Avenue, Haddon Hts., NJ 08035-1456; 609/547-6890.

**Gothic Records** has released two new compact discs featuring **Frederick Swann** and the Choir of the Crystal Cathedral: *O Magnify the Lord* (G-49048) includes the choir, organ and carillon in works by Swann, Knox, Whipple, Hebble and DeVos. *Four Masterworks for Organ* (G-49049) includes the *Sonata in F Minor*, Mendelssohn; *Passacaglia and Fugue*, S. 582, Bach; *Choral in E Major*, Franck; and *Introduction, Passacaglia and Fugue*, Wright. CD \$16.98 plus postage; cassette \$8.98

plus postage: Gothic Records, P.O. Box 1576, Tustin, CA 800/735-4720.

In July and August, **James Welch** toured Switzerland in a series of concerts and recordings. On July 26, he was the concluding artist for the 29th Annual International Festival of Organ Music in Magadino, in the Canton of Ticino, near Locarno on Lake Maggiore. Held on the Mascioni organ at the Parish Church of San Carlo in Magadino, the festival featured organists from Switzerland, Germany, Poland, Italy, and the US. On July 30 he made a recording for Swiss Radio (DRS) on the 1987 Kuhn organ at St. Paulus Church in Basel. The all-American program consisted of works by Hewitt, Buck, Purvis, Albright, Sousa, and the European premiere of Franklin Ashdowns "Fanfare-Trumpet Tune." The program is being aired this fall on Swiss radio. Concluding the tour on August 4 was a recital at the LDS Church in Winterthur.

**The Cathedral Choral Society** (Washington Cathedral) has announced the winner of its second National Young Composer's Contest for a Christmas choral composition. He is Cary Boyce, age 35, Associate Instructor and third year doctoral student in composition at Indiana University School of Music in Bloomington. The anthem is an cappella setting for large chorus of the Magnificat antiphon, *Hodie Christus Natus Est* (Today Christ in born).

Boyce, a native of Santa Rosa, CA, holds the MMus in composition from North Texas State University, and is an active performer, conductor, tenor soloist, and pianist for several ensembles including Pro Arte at Indiana and Collegium Musicum at North Texas. He has studied composition with Martin Mailman, Eugene O'Brien, and currently, Claude Baker.

The three judges were Dr. Richard Wayne Dirksen, whose history as artist, composer, organist, choirmaster, conductor, teacher and Canon Precentor at Washington National Cathedral spanned forty-nine years; Dr. Robert A. Harris, Professor of Conducting and Director of Choral Organizations at the Northwestern University School of Music in Evanston, IL; and Bertha Terry Donahue, violist and composer of numerous choral and instrumental compositions. Eighteen entries from ten states, the District of Columbia and Canada were considered.

Close second and third place choices

were Brian Nathan Fairbanks of Seattle, WA, and Gary Patrick Davison of Dallas, TX.

First place winner Cary Boyce was awarded a one thousand dollar prize. The competition is part of the Cathedral Choral Society's 50th Anniversary celebrations, and follows in the Society's tradition of being a showcase for young soloists and composers. The winning work will be premiered at its annual Joy of Christmas concerts on December 14 and 15.

On September 28, **Washington National Cathedral** held its first open house after the completion of the cathedral. Master carver Vincent Palumbo demonstrated the stone carver's art; Cathedral Carillonneur Edward Nassor presented demonstrations of the carillon; performances took place by the Renaissance Dancers and by Ironweed, a local group featuring hammer dulcimer and guitar music; the great organ was played; a king was on hand to "knight" children at the popular Medieval Workshop; and it was the only day in the year when the public was invited to climb the Gloria in Excelsis Tower, which houses the cathedral's bells.

The 58th annual **Los Angeles Bach Festival** took place at First Congregational Church, October 18-27, Thomas Somerville, artistic director. This year's festival included concerts by Peter Hurford, Igor Kipnis, and the Bach an' All Chamber Ensemble, and a performance of the *Mass in B Minor* by the festival chorus and orchestra.

**House of Arts** has introduced "The Music Organizer." Designed to store a large collection of music, The Music Organizer is made with birch veneer and solid birch trim. The tall, slender design takes up a small amount of floor space. The base measures 15½" x 11¼"; height is 57¼"; 25 storage levels; choice of finishes: satin black, honey maple, walnut, cherry, or natural for \$365; unfinished \$335. House of Arts, 282 Stepstone Hill Rd., Guilford, CT 06437; 203/458-2533.

**VQR Digital** has announced the release of three new recordings. *A Child is Born: Christmas at the National Shrine of the Immaculate Conception* (VQR 2021) features the Shrine Choir with Leo Nestor, director of music, and Robert Grogan, organist. *Ave Maria* (VQR 2041), with Sue Ann Pinner, soprano and director, highlights the historical progression of sacred music in the Roman Catholic Church, most specifically, Marian music. *The Wind of Heaven* (VQR 2051) includes sacred choral music by K. Lee Scott with the Lee Scott Singers, directed by the composer, Sue Mitchell Wallace, organ, Henry Rubin, violin. Available in compact disc (\$15.95 plus \$1.50 P&H) and real-time cassette (\$9.98 plus \$1.50 P&H). For information: VQR Digital, P.O. Box 302, Needham, MA 02192; 617/444-8687; fax 617/444-9812.



John Obetz

RBW Records announces the release of *Auditorium Organ Christmas Encores* featuring organist **John Obetz**.

For his first digitally recorded Christmas CD and cassette, Dr. Obetz has chosen pieces that have proven to be audience favorites over the years he has produced his weekly radio program, *The Auditorium Organ*. Nine of the 22 selections are familiar carols, and another nine are arrangements of carols reflecting the musical traditions of America, Austria, Belgium, England, France and Germany, and representing styles ranging from the 18th to the 20th centuries. This is Obetz' second CD to be recorded in Stereosurround, and is

20th Annual  
**Undergraduate  
ORGAN  
COMPETITION**  
OF THE  
**FIRST PRESBYTERIAN  
CHURCH**  
Ottumwa, Iowa  
Sunday, March 22, 1992  
1st Prize: \$800 2nd Prize: \$400  
For information and application  
Competition '92  
P.O. Box 733  
Ottumwa, Iowa 52501  
Postmark deadline  
January 21, 1992

University of Redlands  
School of Music  
Sixth Annual  
**REDLANDS ORGAN FESTIVAL**  
20 • 21 • 22 January 1992  
Featured Artists and Lecturers  
❖ Michael Gailit, Austria      ❖ Thierry Mechler, France  
❖ Barbara Harbach, USA      ❖ Robert Parkins, USA  
❖ David McVey, USA          ❖ Samuel John Swartz, USA  
Advance Registration-\$165  
(before 20 December 1991)  
On-Site Registration-\$180  
Contact for Information: Dr. Samuel John Swartz  
Redlands Organ Festival, School of Music  
University of Redlands  
PO Box 3080, Redlands, California 92373-0999  
(714) 793-2121 x3260

American & European  
Concert Organists  
& English Choirs  
PHILLIP TRUCKENBROD  
CONCERT ARTISTS  
PO Box 270069  
West Hartford CT 06127-0069  
Phone (203) 233-5858  
Fax (203) 233-8331

# BUZARD: EXPECT THE BEST



IN THE PLANNING and construction of new organs, Buzard Organ Company craftsmen combine artistic discipline and solid engineering to fulfill the architectural and musical needs of a congregation. Each instrument is custom-designed to enhance its particular setting, to provide longevity of service and ease of maintenance, and to meet the client's specific requirements.

At our new factory in Champaign, Illinois, journeymen and apprentices work under Master Organbuilder John-Paul Buzard, who also serves as Curator of Organs to the University of Illinois, Illinois Wesleyan University, and MacMurray College.

When you purchase a Buzard organ, expect the best! We'd be proud to show you our work. To arrange a visit or request a brochure, write us or call toll free 1-800-397-3103.



*John-Paul  
Buzard*

*Organ Craftsmen, Inc. ♦ 112 West Hill Street ♦ Champaign, IL 61820*

## Carillon News by Brian Swager

### Composition competitions

The Guild of Carillonneurs in North America has announced a competition in the interest of encouraging new works composed expressly for the carillon. Works must be between four and ten minutes' duration and must be submitted by January 15, 1992. First prize is \$800, second is \$400, and winning pieces will be premiered at a congress of the GCNA. Complete regulations are available from John Gouwens, Attn Composition Competition, CMA Box 133, Culver, IN 46511.

The Belgian Carillon School has also announced a carillon composition contest. The winner will be awarded the Jef Denyn Prize, 30,000 Belgian Frank, and the composition will be featured as the obligatory work in the 1993 Queen Fabiola International Carillon Competition. Two other prizes may be awarded in this category for virtuoso works, and a second category is reserved for pieces based on an old folk song or the like. Compositions must last between six and seven minutes, and must be submitted by March 31, 1992. Complete information and regulations are available from the school at Fred. de Merodestraat 63, 2800 Mechelen, Belgium.

### Japan discovers the carillon art

The carillon, as an instrument, is

relatively new to Japan. The first came in 1985 as a gift from the Flemish government on the occasion of the city of Osaka's 400th anniversary. In 1988, a 25-bell automatic carillon was made for the city of Nagoya. Next in line was Itami, with a carillon that is playable manually from a baton-type keyboard.

A new 50-bell carillon was delivered by the Royal Eijsbouts Bellfoundry of the Netherlands to the Shinji Shumeikai, an esoteric school in Shigaraki (Shiga), Japan. The carillon, with a burden of 8,000 lbs., was installed in an elegant, white, 200-foot tower designed by the famous Chinese architect I.M. Pei. The tower stands near a temple on the campus which is situated in the center of a nature reserve and surrounded by a mountainous landscape. Eight gigantic sculptures—reminiscent of the Easter Islands—loom over visitors, who are invited to partake in the traditional Japanese purification ritual at a sparkling waterfall. Given this setting, the crystal clear sounding bell tones whirling down from the sky have inspired the Japanese to name the instrument "Joy of Angels."

Jo Haazen, director of the Royal Belgian Carillon School and Mechelen City Carillonneur, played the dedicatory recital on December 23, 1990 for no less than 15,000 enthusiastic listeners.

## Music for Voices and Organ by James McCray

### Music with additional solo instruments (Flutes and Trumpets)

*The Spirit of the Lord came upon Gideon, and he blew a trumpet.*  
Judges 6:34

*The flute is not an instrument which has a good moral effect: it is too exciting.*  
Aristotle, *Politics*

The two most common instruments added to choral singing, especially in church, are probably the flute and the trumpet. They provide very different moods. The flute, quite often, is a gentle addition that flows into the music and adds a passive or haunting quality; it

blends well with the voices and/or organ. The trumpet tends to be used with a stronger, bravura style. It is majestic or festive, and has the tendency to overpower a choir unless the performer is very sensitive to the situation.

Both instruments have numerous players, and usually can be found in abundance in most congregations. There are many settings and arrangements which use these solo instruments with choirs. What makes these instruments used so frequently? It might be their immediacy. A survey of any public school band program will reveal that these are popular instruments. Although they are not considerably easier to play than most other band instru-

ments, they are easier than some. Band directors often have to coerce students into playing instruments such as the tuba, the baritone horn, the bass clarinet, etc., but with the flute and trumpet, it sometimes is a matter of trying to discourage students from taking them. At our annual summer music camp for students age 12-18, we have more flute players register than all of the other woodwind instruments combined! And, in the brass area, the trumpets almost have the same situation although the total number of brass is lower than woodwinds.

Do people choose flute because it is easy to carry? Maybe. It is more likely that it is relatively inexpensive, easily learned, has a place of prominence in both band and orchestra. The trumpet tends to be a hero instrument, and its music has a flashy character that is especially attractive to boys. Nevertheless, whatever the fascination, composers use these two instruments with great frequency in both sacred and secular works. The body of literature available to conductors is considerable.

With lots of music and players it is only natural that church choirs should program this material with some degree of frequency. The addition of these popular instruments can create a distinctly new mood for a service, and with limited rehearsal, they quickly can be integrated into the music. Also, since there is a massive amount of solo/keyboard literature for them, it is easy to also use them for an offertory on that same service day, which gives yet another color of sound to the service. Even performing a simple hymn setting on one of the instruments can be effective. Choose a common hymn, let the soloist play the melody, give the organist an opportunity to play the second stanza with some "additional" improvisation if possible, and return the solo instrument for a third verse. Simple, instantaneous offertory music that will please the congregation.

The music reviewed this month features these two common instruments with choral/keyboard settings. Have a Happy 1992. Next month will begin the reviews for the Lenten/Easter season.

### Trumpet music

*God is my rock*, Allen Pote. SATB, keyboard, and optional trumpet, CPP/Belwin Mills Inc., BSC00131, \$1.10 (M-).

Based on Psalms 62 and 90, this fast, driving setting has many modulations as the verses unfold. The trumpet part is different from the keyboard music,

and is a vital part of the music's spirit. At times the choir moves into unison and two-part music; the last verse treats the soprano line as an obbligato which doubles the trumpet before returning to the opening material. Keyboard material is easy with some polychords in the left hand that require all five fingers. The choir and congregation are certain to enjoy this one. The trumpet (B<sup>b</sup>) music is on the back page. Highly recommended.

*Let all the people praise thee*, Natalie Sleeth. Two parts (any combination), keyboard, and trumpet, The Sacred Music Press, S-474-3, \$1.10 (E).

This is one of the Sleeth anthems that has a lively rhythmic accompaniment, easy singing for the voices, and involves the congregation in a familiar tune. In the middle they join the choir on Croft's famous St. Anne (O God Our Help), while the choir sings in four parts (optional), or in unison with the keyboard playing their SATB parts as accompaniment. At the end, the dancing, rhythmic opening returns and builds to a joyous, loud closing. The trumpet is also on a separate back page. A sure winner.

*O day of rest and gladness*, Johann Steurlein (1546-1613), arr. by S. Drummond Wolff. SATB, organ, and trumpet, Concordia Publishing House, 98-2907, \$1.00 (M).

The trumpet is soloistic, but not difficult. Each of the verses sung by the choir has a different setting but retains the basic hymn tune; some have contrapuntal lines, but generally a homophonic texture prevails. The accompaniment is chordal and provides a solid support for the singers. This is a useful anthem that has vigorous energy and good part writing. The trumpet part is on the back cover.

*I will exalt you*, Peter Mathews. SATB, organ, and trumpet, Morning Star Music Publishers, MSM-50-7003, \$1.50 (M+).

The trumpet music is busy at times, with a recurring triplet motive that is used throughout; there are a few high notes, but all are well within the ability level of an average player. This anthem has depth, good craftsmanship, and is something that will take a bit of work to perform. Sections are exposed, and the organ writing, on three staves, is also soloistic. The music has quality and a freshness without being highly dissonant. There are several sections with varying tempi in the 16 pages of music. It will need a solid choir, and will be suitable for a festive, special occasion. Good writing.

*Day by day*, Jonathan Willcocks. SATB unaccompanied, with trumpet, Roger Dean Publishing Co. of Lorenz, HRD 322, \$1.10 (M+).

Using the celebrated St. Richard of Chichester text popularized in the 1960s Willcocks has created a sensitive, mildly dissonant anthem that, at times, is contrapuntal. The trumpet here remains quiet and its fanfare passages, which are interspersed throughout, create a different quality at the soft level. The slow tempo and interesting harmonies combine into a thoughtful setting. ▶

## Find Out Why Schulmerich Bells Are The Right Choice For You.

Enhance your worship celebration easily and affordably with the inspiring sound of Schulmerich Bells. We offer a full range of handbells, cast bronze bells, carillons, keyboards and automated bell instruments.

A leader in bell music technology since 1935, our bellwrights have earned a reputation for innovations in bell design and outstanding craftsmanship.

Call for your FREE brochure today.



# SCHULMERICH CARILLONS, INC.

The bell capital of the world.

Dept. M40112 • Carillon Hill • Sellersville, PA 18960  
215/257-2771 FAX: 215/257-1910



ORGAN AND CHORAL MUSIC  
recorded in Britain's Historic Cathedrals, Churches, and Schools  
by Abbey of Oxford. FREE Catalog  
from: Bradford Consultants, P.O.  
Box 4020, Alameda, CA 94501.

**Scott R. Riedel**  
CONSULTANT IN ECCLESIASTICAL  
ACOUSTICS, MUSIC & ARCHITECTURE

11040 West Diamond Road, Wauwatosa, Wisconsin 53226  
(414) 771-8966

## Flute

*Amazing grace*, arr. William D. Hall. SATB, flute, and piano, National Music Publishers, WHC 25, no price given (M-).

Hall suggests that the flute part could be whistled; its music is a gentle, folk-like tune that is heard as a solo with the keyboard and as a countermelody to the singing. There is one brief section for unaccompanied two-part women that leads to a section for two-part men with accompaniment. The familiar tune is always present throughout the verses. Attractive setting, and useful for young voices as well.

*Journey of faith*, Robert A.M. Ross. SATB, organ, flute, and optional congregation, Theodore Presser Co., 312-41561, \$.90 (E).

Most of this setting is in unison. The music has quiet, flowing lines that are chant-like, and the text tells a story. The organ is on two staves with registration suggestions. There is an ethereal quality to the music; often the organ holds chords for several measures while the voices and/or flute weave above it. The last verse has a four-part unaccompanied choral setting that then ends quietly with the organ and flute. Lovely, easy music.

*Not unto us, O Lord*, Richard Wienhorst. Unison, keyboard, and flute, Augsburg Fortress Publishing, 11-4690, \$.80 (E).

Using a fragment of Psalm 115, this setting could be sung by a soloist or unison choir. Much of the three-page setting is for flute and keyboard. The music is quite easy, especially the keyboard; the flute has a modal, tuneful theme with notated ornamentation which is later reflected in the vocal line. Simple, charming music.

*Sheep may safely graze*, J.S. Bach (1685-1750), arr. by James Winfield. SATB, 2 flutes, and organ, Somerset Press of Hope Publishing Co., MW 1244, \$1.10 (M).

This arrangement of the popular movement from Bach's Cantata 208 (Hunt Cantata) gives the flutes the flowing melodies. The keyboard material is considerably easier than the original, and the chorus sings the typical homophonic music; later the text paraphrases the 23rd Psalm. There is repeated material and a coda. Easy enough for most church choirs, and a setting to show off two fine flute players whose music sounds more difficult than it is.

*This child of ours*, Paul D. Weber. SATB, organ, and flute, Augsburg Fortress Publishing, 11-2532, \$1.00 (M-).

The Jaroslav Vajda text is appropriate for a child's Christening, and concerns what parents do in raising a child. The words are very sensitive and touching. The flute part often plays very high, and has a busy part with changing articulations. Much of the choral music is in unison with the second verse in a four-part unaccompanied setting at a faster tempo. Lovely music that, if used for Baptisms/Christenings, will certainly speak to the tender feelings of the parents and the congregation.

## New Recordings

*Christmas at York Minster*. The Choir of York Minster; Philip Moore, Organist and Master of Music; John Scott Whiteley, assistant organist. York Ambisonic CD 846 (compact disc DDD). Stereo/Ambisonic UHJ surround sound. TT 56:26.

John Goss: *See amid the winter's snow*; Lennox Berkeley: *I sing of a maiden*; William Mathias: *A babe is born*; John Gardiner: *Tomorrow shall be my dancing day*; Praetorius/Moore: *I sing the birth*; Peter Warlock: *Benedicamus Domino*; Scheidt/Willcocks: *A child is born in Bethlehem*; Cornelius/Atkins: *The three kings*; Traditional Car-

ols: *We've been awhile a-wandering; Away in a manger; I saw three ships; O come, o come Emmanuel; A great and mighty wonder; O little town of Bethlehem; Unto us a boy is born*; Organ Solos: Henri Mulet: *Noël*; Edouard Commette: *Offertoire sur des Noël's*; John Ireland: *The holy boy*; Louis Vierne: *Carillon de Longpont*.

Listeners wanting just one seasonal sampler of British smells and bells in their record collection can find more attractive and evocative programs than this one from York; however, those of us who love this repertoire can happily add this disc to the stack in spite of its flaws. The York Minster choir has neither the musical discipline nor the perfect blend of more frequently recorded English cathedral choirs. The boys produce a keen, well-projected sound some people may prefer to the flute-like quality of, say, King's College or Christ Church, Cambridge. The high points of this generally understated program are the anthems by Berkeley, Mathias, Gardner and Warlock. Assistant organist Whiteley ends the disc with an attractive reading of the Vierne *Caril-*

*lon*. Ambisonic surround-sound reproduction requires a special decoder as well as a second amplifier and set of speakers. Conventional stereo playback gives a multi-miked image with close-focus for choral detail and a surrounding haze of reverberation. The organ speaks from far away. Further comments on Ambisonic sound will have to wait until Santa brings this reviewer a new sound system.

—Randy L. Neighbarger  
Chapel Hill, NC

*Candlelight Carols*. The Choir of Trinity Church, Boston, with brass, timpani, flute, and organ, in a program of Christmas carols conducted by Brian Jones. London 430 456; compact disc and cassette.

Trinity Church is one of Boston's oldest Episcopal parishes, with a venerable musical tradition. Brian Jones, director of music and organist at Trinity since 1984, is only the latest in a long line that includes such figures as William Selby, James Hewitt, and Horatio Parker. Jones is also in his 25th season

as director of the Dedham Choral Society. The results of his labors are on display in *Candlelight Carols*, Trinity's new release for London/PolyGram Records. This album's nineteen holiday selections range across the repertoire, from the familiar—staples like the "Carol of the Bells" and "O Little Town of Bethlehem"—to several real finds.

One of these, Hugh MacKinnon's "Sleeps Judea Fair," is a tender, pensive setting that evokes Berlioz' "Shepherd's Farewell," from *L'Enfance du Christ*. The choir is stirring in the second verse's *a cappella* opening, and soprano Johanna Schlegel intones her brief solo with childlike innocence.

Also welcome are John Rutter's several compositions and arrangements featured here. "I Wonder as I Wander" sets soprano Anna Soranno's lush tones against the leaner sound of the chorus, while "Candlelight Carol" offers a striking obbligato by flutist John Ranck.

Striking as well is Richard Purvis' arrangement of "What Strangers Are These?," a traditional Scottish carol that captures the bone-weariness of Mary and Joseph as they seek lodging. Bari-



Choong Hyun Presbyterian Church in Seoul, Korea, is one

of the world's largest churches. The congregation numbers approximately 24,000. There are four services each Sunday, and many more during the week. The church has seven choirs, each with its own director and organist. Music is a vital part of its ministry. In the early 1980s, Choong Hyun broke ground on a magnificent new building. In the fall of 1983, the congregation purchased a large two-manual Allen Organ for its recently completed 2,000-seat chapel, where services were held as construction continued. In 1986, the congregation moved into its new sanctuary of more than 5,000 seats; and the search began for a large pipe organ. Representatives of the church and their consultants traveled around the world auditioning organs of many builders.

The church was prepared to commit whatever resources were necessary to get the best organ available. After three years of travel and evaluation, the search came down to one choice. The people of Choong Hyun purchased a second Allen Organ — a four-manual instrument of 107 stops. People who own Allens buy Allens. There is no higher endorsement for an organ.



"And the end  
of all our  
exploring will  
be to arrive  
where we started  
and know  
the place for  
the first time?"

—T.S. Eliot

**Allen organs**

Copyright © 1991  
Macungie, PA 18062-0036  
215-966-2202

tone Christopheren Nomura's atmospheric solo turn forms the hub of Herbert Howells' "A Spotless Rose."

Organist Ross Wood and a fine ensemble of percussion and brass players really deliver the goods in David Willcocks' flashy arrangements of "O Come, All Ye Faithful" and "Hark! The Herald Angels Sing." Wood makes the most of Trinity's wonderful Aeolian-Skinner organ in John Ferris' virtuosic arrangement of the old French carol, "Joseph est bien marié."

The engineering, by Bruce Humphrey, faithfully renders Trinity's famously resonant acoustic. Another nice touch is the cover art, which reproduces a splendid painting of Trinity Church and Copley Square in winter by Boston artist Thomas R. Dunlay. All in all, this is one of the most satisfying Christmas albums to come down the pike in a long time. It bodes well for further releases from London/PolyGram featuring Jones and the Trinity Church Choir that are reported to be in the works.

—George W. Harper

**Great Music of Christmas. The Cathedral Choir, The Boys and Girls Choir, St. John's Cathedral, 1313 Clarkson Street, Denver, CO 80218. Donald Pearson, director. James Garvey, assistant organist. The Aries Brass Quintet and other instrumentalists. Cassette—\$8.95; CD—\$14.95.**

Contents: *Hark the herald angels sing; It came upon the midnight clear; Lo, how a rose e'er blooming; Unto us a boy is born; Away in a manger; While shepherds watched their flock by night; A child is born in Bethlehem; The angel Gabriel from heaven came; The snow lay on the ground; A la ru; From heaven above to earth I come; 'Twas in the moon of wintertime; Angels we have heard on high; Joy to the world; O little town of Bethlehem; Lully, lullay; God rest you merry, gentlemen; Nova, nova; In the bleak midwinter; On this day; A stable lamp is lighted; Now greet the*

*swiftly changing year; Silent night; Good Christian friends, rejoice; What child is this; O come, all ye faithful.*

Organ: 1938 Kimball.

As Ray Glover says in the notes which accompany this recording, "Many of the settings are exactly as found in The Hymnal 1982 while others are enriched in anthem-like settings with descants, free accompaniments for organ and glorious arrangements for brass." There is a wide variety of sounds presented in these arrangements—from simple harmonizations to very festive settings. It is especially interesting when two different tunes are used for various stanzas of a particular carol. There is very interesting and colorful use of instrumentation and a cappella singing, including arrangements by the director himself. The choir exhibits good blend and enunciation. Perhaps more variety in dynamics and better musical phrasing would have made this a superb choral presentation as well as an excellent presentation of hymn singing. There is some attention to those details, but there could have been more.

This recording will give many ideas to choral directors and organists as they prepare music for their Christmas services. A lot of imagination and preparation has gone into the making of this recording that will be of immense interest to many.

—Dennis Schmidt, DMA  
St. Paul's School  
Concord, NH

**Buxtehude Christmas Concert. McGill Chamber Singers and Collegium Musicum directed by Fred Stoltzfus, organ solos by John Grew. McGill Records 750029-2. Available from McGill Records, 555 Sherbrooke St. West, Montreal, Quebec, Canada H3A 1E3. No price given.**

The disc, with over 73 minutes of music, offers six cantatas: *In dulci jubilo* (Christmas); *Wie soll ich dich empfangen* (Advent); *Wachet auf, ruft uns die*

*Stimme* (Advent); *Kommst du, Licht der Heiden* (Advent); *Das neugeborne Kindelein* (Christmas); and *Alles was ihr tut* (Epiphany). Between each cantata, John Grew, University Organist and Chairman of organ and harpsichord studies at McGill University, plays a Christmas or Advent chorale prelude. Two of these, the often played "Wie schön leuchtet der Morgenstern" and the less known, but more interesting "Gelobet seist du, Jesu Christ," are correctly referred to as choral fantasias in the accompanying notes.

The Collegium Musicum consists of two violinists, one violist, one cellist, and one organist, all of them using instruments constructed in the Baroque style. The organ is clearly a small positive. The cantatas range from just under seven to about twelve minutes in length and vary considerably in form, complexity, and mood. The first four are for three-part choir—SAB, SSB, ATB, and SAB respectively. Buxtehude's large output of cantatas is still too little known, and it is easy to forget that he was as important in the early history of the cantata as in the field of organ music. All the works on this disc are worth hearing often, but the real gem is surely *Wachet auf* with its infectious rhythms and expressive contrapuntal passages. This cantata deserves to be performed more frequently than it is, perhaps even instead of Bach's famous treatment of the same chorale.

The performers are all students or faculty members of the McGill Faculty of Music. There are seven soloists—four sopranos, one alto, one tenor, and one baritone. With the exception of the baritone Steven Lecky—an exception that has no apparent reason—all are members of the chorus. With the possible exception of Maria Ciccaglione, none of the solo voices are outstanding, but they are all pleasant and intelligently used; above all, the soloists are stylistically perfect.

The choir deserves nothing but praise. Stoltzfus obviously favors a clear, light tone, occasionally perhaps sacrificing richness of tone to clarity. The performances are buoyant and very stylish as well as technically sound and tonally impeccable. Some listeners may prefer a more robust approach rather than the chamber music effect achieved here. It is legitimate to wonder whether these performances would come across in the acoustically live but vast spaces of Buxtehude's home church, the enormous Marienkirche in Lübeck. One might add that the German diction is excellent and refreshingly free of the exaggerated sounds so often emitted by English-language choirs performing German texts.

John Grew plays the Beckerath organ of Queen Mary Road Church in Montreal. This instrument, installed in 1959, is regarded as the first modern tracker organ in Canada and it was the first Beckerath organ in the country. Grew makes excellent use of the reed and mutations stops available and gives restrained but convincing performances of five varied pieces. The several sections of the fantasia on "Gelobet seist du" are welded into a most satisfying unit. The organ sound is a delight in itself.

The accompanying booklet is a model. The cantata texts are given in the original and in excellent English and French translations. Conductor and

organist provide helpful notes on the music and, in the case of the organ works, some remarks about the registrations. The only possible complaint is that the organ specification is not given. However, the organ has been discussed in various publications, and the specification is fairly readily available.

Highly recommended on every count!

W.G. Marigold  
Urbana, IL

## Vocal Solos

**Sateran, Leland B., *We Three Are One, a Wedding Song*, Art Masters Studio, Inc. \$1.25.**

While one appreciates every attempt to lift sacred vocal wedding music out of its oft-maudlin habits, there are some more successful than this. Grace Jewel Jensen's text refers to a supreme being only in masculine pronouns and saccharine images. A vocal range of a 12th, including three octave leaps, are requirements which, if met, could be better applied to music of more substance.

**Held, Wilbur, *Six Seasonal Solos*, Augsburg, \$8.00.**

The inclusion of the duplicate accompanist's copy in the format (and price) is gratefully hailed. One selection is included for each of six liturgical seasons (Advent, Christmas, Epiphany, Lent, Easter, Pentecost). The texts are uniformly beautiful, although three have strong associations with other tunes. Vocal ranges within the octave, traditional harmony and technical simplicity suggest beginning soloists, or small-group unison singing, perhaps at home.

**Tecson, Andrew, *Sing Unto the Lord*, Concordia 97-6042, \$6.00.**

Again we acknowledge with thanks the two-copy format. This is a setting for solo voice (high) and piano (arrangement by Carolbeth True) in a jazz idiom. The text, by the composer, is based on Psalms 98 and 100. It is wonderfully expressive; the text-tune accents are exceptionally good. The middle section, exactly one-third of the piece, is for piano alone. Though the printed notes are quite adequate, the jazz chord symbols (Dmaj7, Bmi7, etc.) suggest that well-chosen improvisatory embellishments would be welcome. Sacred jazz this well-made could make believers out of some of our more conservative colleagues. It is worth a look!

—Scott Withrow  
Central Congregational Church  
Providence, RI

## New Organ Music

**The Organ Symphonies of Charles-Marie Widor (Belwin Mills/PPP), vol. I—Symphonies I–IV; vol. II—Symphonies V–VIII, *Symphonie Romane*.**

Many years ago, I played a recital which included a movement from Widor's *Symphonie Gothique*, and I well remember an organ enthusiast in the audience being particularly intrigued:



## BRUNZEMA ORGANS INC.

596 Glengarry Crescent South  
Post Office Box 219  
Fergus, Ontario Canada  
N1M 2W8 (519) 787-0033



"BRILLIANT" . . . *The American Organist*

"FIRST RATE" . . . *PIPEDREAMS*

"A VIRTUOSO ORGANIST TO RANK WITH ANY" . . .  
*The New Records*

"A MAGNIFICENT PERFORMANCE . . . serious without pretense, joyous without frivolity, and thoroughly captivating" . . . *The State* (Columbia, SC)

SECOND PRIZEWINNER: "Grand Prix de Chartres," 1988  
St. Albans International Organ Competition, 1985

DIANE MEREDITH BELCHER  
ORGANIST

For availability and further information, contact:  
1880 Vinton Ave., Memphis, TN 38104 (901) 274-0815

before that concert, he sincerely believed that Widor had written only one symphony, namely the *Fifth*.

Well, Belwin Mills provides evidence that *Symphony V* was preceded by four others, and that more were to come. (One presumes that the ninth—the *Gothique* is some sort of black sheep, and, therefore, to be avoided, hence its non-appearance here.) The present two volumes are reprints, and, looking at the prices, are exceptionally good value: I remember buying most of my Widor symphonies in England and France (dreadfully expensive French copies) and, at that time, would have given my eye teeth for these two Belwin volumes.

Much fine research has been carried out into Widor and his music in recent years, notably by the American organist-scholar John Near. In particular, his doctoral thesis on Widor's life and work (Boston University, 1984) should be prescribed reading for anybody who plays the composer's music. Dr. Near is preparing the symphonies in a new scholarly edition (A/R Editions) which, one hopes, will become the standard version used by all performers in the years to come.

Although it cannot be denied that this edition is easy on the wallet, one must sound a fairly hefty caveat to the player in search of a reliable text from which to work. Widor himself published various editions of the symphonies, and rarely ceased to revise his work. This is particularly true of the first four symphonies: for example, *Symphony II*, which first appeared in 1872, acquires its *Salve Regina* nearly thirty years later in the 1901 edition, when the *Scherzo* from the same symphony is discarded. It is a matter of personal taste as to whether some of these changes 'improve' the symphonies: I have always felt that the *Salve* is a rather incongruous addition, although it would be perfectly at home in the more rarefied atmosphere of, say, the *Symphonie Gothique*, or the *Symphonie Romane*. Likewise, the removal of the dignified *Prélude* from *Symphony VIII* during the same period of revision is sad, especially since editions such as the present one fail to recognize that it ever existed: why not print it as an appendix?

Another problem with these reprints is the failure to correct errors (flats which should be naturals, naturals which should be flats, and so on) which seem to have been with us for many a year. Anybody wishing to learn *Symphony IV* will encounter this particular hurdle fairly soon. In addition, the print is not distinct, and often difficult to read. And the copies don't lie flat on the music desk—hardly 'user-friendly' to a player tackling the complexities of *Symphonie VIII*, for example.

The need for a good, legible, accurate edition of the Widor Symphonies—including movements excised from later editions, details of revisions, and a thorough preface—is long overdue: Dr. Near's *urtext* is awaited with bated breath. Although the present editions are flawed, they do contain some terrific music, music which has been subjected to scandalous neglect over the years. For the very fact that they exist, one should be grateful: how much of Widor's *oeuvre*—which cries out to be performed—is either unavailable, or accessible only through visits to certain libraries!

Bearing all this in mind, one perhaps should not dissuade those wishing to play Widor's organ symphonies from buying these editions as stop-gaps: keep an eye open for Dr. Near's forthcoming editions, and do read his dissertation!

—Mark Buxton  
Toronto, Ontario

*Peace Prelude*, Joe Utterback. Jazz-muze 1991-003-01. \$7.50.

The subtitle of this composition reads: "An organ meditation on the beauty, quiet joy, and strength of peace." These adjectives then are described musically in this piece in sec-

tions marked "flowing, relaxed, introspectively," "very warm, rich, moving" and "full, loud, grand, expansive." The piece begins with a haunting melody which will be the main theme in all sections of the piece, first beginning ethereally in the manuals. Subsequent voices follow in imitative style and in inversion. The pedal then produces the same theme in augmentation in a different key. The feeling of a definite key center appears more sharply focused in the second section, as arpeggiated chords accompany the pedal melody. The third section begins with the same music as the beginning, only with a stronger registration and the pedal notes in octaves. The arpeggiation of the second section is taken up again in the right hand as the registration gets stronger and stronger. Big chords expanding outward from the center conclude the piece on a rather surprising E-flat 7th chord.

The piece is very well written and descriptive of the many sides and aspects of peace. It was composed during the time of the Persian Gulf War for a service which included Haydn's *Mass in Time of War*, and would make a good addition to any service or recital which concentrates on the theme of peace.

*Tu es Petrus; Grande Pontificale pour Orgue*, Roger Matton. Les éditions Ex Arte Enrg. No price listed.

This work was written by Canadian

Roger Matton to celebrate Pope John Paul II's pontifical visit to Quebec City in 1984. It is based on four principal themes: the antiphon "Tu es Petrus," the hymn "Veni Creator," the antiphon "Salve Regina" and a free invention on the word pattern "Tu es Petrus." Suggested registration for the piece is given at the end.

Fanfare- and toccata-like writing provides the bulk of the texture. This is a very captivating piece that will add an air of excitement to a festival service. The composer is fond of 9th, 11th, 13th, etc. chords, which are a big part of the homophonic sections. The contrapuntal sections may be a bit tricky, as each hand follows a different pattern in run sequences. It is a challenging piece, but well worth the time spent to learn it. It should be a hit.

*Classical Keyboard Pieces for Beginners*, compiled by Jacques Van Oortmerssen. Edition Boeijenga Sneek. Available from Church Music & Records, Box 154, Neerlandia, Alberta, Canada T0G 1R0. US \$9.60, Canadian \$12.00.

The introduction states: "The pieces in this collection were written specifically for the musical education of beginners, and appropriate to all keyboard-instruments: piano, harpsichord, clavichord and organ." The pieces are taken from various published methods and collections. It could be compared to a

"John Thompson" graded method for keyboard. Usually there is one note per hand, although occasional duet and trio parts are written. The collection includes works by Christian Friedrich Ripper, J. C. (or C.P.E.?) Bach, Thomas Haigh and Samuel Arnold. The pieces are sonatas, minuets and lessons. All are fingered.

This may be a good collection for early training of keyboard technique.

*Sonata in Do Maggiore*, Gioacchino Rossini. Boccaccini & Spada Editori, Roma (Theodore Presser Co., selling agent). No price given.

Although this composer, known for his operas, did not write many works for organ, this sonata was found in a non-autograph manuscript collection of works by several Italian composers. The style of the music is very simple, almost harpsichord-like in construction. The right hand has charge of the melody, with frequent arpeggiated chords, while the left hand usually plays two- or three-note chords to accompany. There is no pedal part, probably owing to the limited pedal of Italian organs of the time. This is a short one-movement sonata which gives an example of a very elementary style. Perhaps it is the work of a very young Rossini?

—Dennis Schmidt, DMA  
St. Paul's School  
Concord, NH



**peterson**  
ELECTRO-MUSICAL PRODUCTS, INC.

*The finest in electronic & electro-mechanical equipment for the Pipe Organ.*

<ul style="list-style-type: none"> <li>• DYNATREM TREMOLOS</li> <li>• MASTER TOUCH KEYBOARDS</li> <li>• KEY CONTACT ASSEMBLIES</li> <li>• PEDAL REED CONTACT ASSEMBLIES</li> <li>• ELECTRIC PIPE VALVES</li> <li>• ELECTRIC PRIMARIES</li> <li>• SUPER VALVES (PEDAL VALVES)</li> <li>• JUNCTIONS</li> <li>• PRE-TERMINATED CABLES</li> <li>• CRESCENDO SETTERS</li> <li>• CONSOLE CABLES</li> </ul>	<ul style="list-style-type: none"> <li>• SOLID STATE SWITCHING SYSTEMS.</li> <li>• MULTI-LEVEL MEMORY COMBINATION ACTIONS.</li> <li>• DIGITAL MEMORY LEVEL READOUTS</li> <li>• DIGITAL TRANSPOSER READOUTS</li> <li>• PROGRAMMABLE CRESCENDO &amp; TUTTI SYSTEMS</li> <li>• ORGA-PLEX (MULTIPLEX) SWITCHING SYSTEMS.</li> <li>• ORGA-PLAY PERFORMANCE REPRODUCING SYSTEMS.</li> <li>• TONGUE TAB ASSEMBLIES.</li> <li>• ROCKER TABLET ASSEMBLIES.</li> <li>• DRAWKNOBS</li> <li>• CATHEDRAL CHIMES</li> <li>• CHIME ACTIONS</li> <li>• CHIME RELAYS</li> <li>• MANUAL TRANSFERS</li> <li>• PISTON TRANSFERS</li> </ul>	<ul style="list-style-type: none"> <li>• PISTON COUPLERS</li> <li>• EXPRESSION PEDALS</li> <li>• EXPRESSION SHOE REED CONTACT ASSEMBLIES.</li> <li>• MIDI INTERFACES</li> <li>• ELECTRONIC PEDAL RANKS</li> <li>• CONSOLE CLOCKS</li> <li>• REVERSIBLES</li> <li>• ENGRAVING</li> <li>• TUNERS</li> <li>• SLIDER MOTOR CONTROLS</li> <li>• RECTIFIERS (UL APPROVED)</li> <li>• PULSE POWER SUPPLIES</li> <li>• SWELL SHADE OPERATORS</li> </ul>
--	--	---

OUR COMPLETE LINE HAS BEEN DEVELOPED IN AN "ORGAN-IZED" MANNER TO PROVIDE SIMPLE, EFFICIENT INSTALLATION. OUR FULL STAFF OF OVER 80 EMPLOYEES IS READY TO STAND BEHIND EVERYTHING WE SUPPLY.

**WE'RE HERE WHEN YOU NEED US!**

**1-800-341-3311**

Peterson Electro-Musical Products, Inc.  
11601 South Mayfield Avenue/Worth, Illinois 60482

**FAX 708-388-3367**

# Organ Design

## Based on Registration

Robert Noehren

There is a general notion in the organ world that organs designed by men with special knowledge reflect the taste of an organist, an organ builder, an organ expert, or even a committee. There is often the expectation that a new design will represent at least some originality and will not be exactly like any other. But shouldn't a new design be conceived as an instrument which will be ideal for the performance of certain organ music and/or function in the services of the Church?

Most designs today reflect the influence from some source of traditional organ building. While there is concern in general about how such an instrument will function, the design is rarely focused specifically on detailed registrations for actual performance, and one never hears of a design which has been based on a study of registration found in those scores of organ composers whose music is most often performed. Using such a procedure, a designer could simply draw up a list of registers and registrations to be found in organ scores, as the composer has planned and indicated them, much as he has scored the orchestration of a work written for orchestra.

There have been organ builders in the past who were especially concerned about the performance of music for the organ and tried to conceive of their instruments to serve such a purpose. Perhaps the most convincing example of this was Aristide Cavallé-Coll, who appeared in France during the middle of the nineteenth century. For 50 years, from 1840 to 1890, the course of organ building and organ playing in France was dominated by this unusual builder, who, during his lifetime, built some 500 organs and exerted a tremendous influence on music for the organ and the art of organ playing.

Cavallé-Coll conceived an instrument which has remained the inspiration for all the major French organ composers from César Franck to Messiaen. He created an instrument which, in the variety and disposition of its registers and divisions, became one of the most complete and practical mediums of expression in the entire history of the organ. Beginning with Franck, almost all the composers of French organ music throughout the nineteenth and twentieth centuries accepted Cavallé-Coll's conception of the organ as a practical model for their writing. Franck, almost at once, used his new organ at the Parisian Church of St. Clotilde, one of Cavallé-Coll's early instruments, as a model for the registrations he desired. It was a pattern which was to continue, sometimes in more and more detail, by many composers to follow who came under the influence of this unique conception.

It is possible then to study and come to a greater understanding of the general conception of this organ simply by following the music written for it and by discovering the registrations which the composers specified within their scores. Even after Franck and Cavallé-Coll had passed on, this organ remained a model instrument for composers who came later. Charles-Marie Widor, born in 1845, just as Cavallé-Coll was beginning his career, lived well into the twentieth century and, throughout his lifetime, found the Cavallé-Coll organ indigenous to his style. Louis Vierne and Charles Tournemire, both born in 1870, in similar fashion also used and specified their registrations for such an instrument. These composers indicated the registration for all their organ works just as thoroughly as it was necessary for them to orchestrate their works for the modern symphony orchestra.

The instrumentation characteristic of Cavallé-Coll began almost with his first organs. As he sought to increase the expressive possibilities of his organs, Cavallé-Coll also introduced the first serious use of an enclosed division, the Récit, and, during the years which followed, added a second and even a third enclosure in his larger instruments whenever that was possible. However, from the beginning, the pattern of his disposition of the manuals and registers remained similar throughout his career regardless of the size of the instruments, and he tended to create a standardized instrument reflecting the registrations of the composers who wrote for the instrument. For instance, one invariably finds four 8' flue registers consisting of a *montre*, *bourdon*, *gambe* and *flûte* to be basic to the Grand Orgue of every Cavallé-Coll organ of more than twenty registers.

Widor, like Franck, specified the registration of all his organ music to fit the instrumentation of the Cavallé-Coll conception. One finds in the movements of his symphonies the registrations he desires at the beginning and throughout the course of each work.

Likewise, Vierne, a pupil of Franck, specified the registrations in all his works for organ. In a study of his works we soon discover indications for a *Positif expressif*, and this tells us that, in the design of a comprehensive instrument, it is necessary to have at least two enclosures, one for the Récit and another for the Positif.

Charles Tournemire, another pupil of Franck and contemporary of Vierne, was even more precise in specifying registrations for his organ compositions. Tournemire was a successor of Franck as organist of the Church of St. Clotilde from 1898 until his death in 1937. During the course of his tenure there and at his instigation, an enclosure for the Positif and several more registers, typical of voices Cavallé-Coll developed and introduced into his later instruments, were added to the organ at St. Clotilde. His major work, *L'Orgue Mystique*, consisting of 51 suites written for the Sundays and feast days of the church year, requires an organ typical of Cavallé-Coll with two enclosures, the usual one for the Récit and another for the Positif. In all his organ scores, Tournemire refers to the manuals by using Roman numerals, and numbers them according to their location on the console: the bottom keyboard is I, representing the Grand Orgue, the next above is II, the Positif, and above is III, the Récit.

In a work for orchestra, it is necessary for the composer to determine the instrumentation he desires as he prepares the score, and for its performance, an orchestra will be assembled containing all the instruments which his score requires. Somewhat in the same fashion, it should be possible to have organs which contain all the registers to be found in the scores of Franck, Widor, Vierne, Tournemire, Alain and Messiaen. It should then be possible to draw up a disposition for an organ by assembling all the registers identified in these scores

Figure 1

I (Grand Orgue) . . . . .	Great Organ.	Basson . . . . .	Fagotto.
II (Positif) . . . . .	Choir.	Hautbois . . . . .	Oboe.
III (Récit) . . . . .	Swell.	Cor anglais . . . . .	English horn.
I, III . . . . .	Swell to Great.	Trompette . . . . .	Trumpet (Cornocean).
I, II . . . . .	Choir to Great.	Clairon . . . . .	Clairon.
II, III . . . . .	Swell to choir.	Bombarde . . . . .	Trombone 16', — or (Tuba magna).
I, II, III . . . . .	Swell and choir to great.	Anches . . . . .	Reeds.
Tirasse I . . . . .	Great to Pedal.	Ocravin . . . . .	Harmonic Piccolo 2'.
Tirasse II . . . . .	Choir to Pedal.	Nazard 2 2/3 . . . . .	Twelfth 2 2/3.
Tirasse III . . . . .	Swell to Pedal.	Plein-Jeu . . . . .	Mixture.
Quintaton . . . . .	Quintadena.	Tierce 1 3/5 . . . . .	Tierce 1 3/5.
Bourdon . . . . .	Stopped diapason.	Cornet . . . . .	Cornet.
Flûte . . . . .	Flute.	Doublette 2 . . . . .	Fifteenth 2'.
Montre . . . . .	Open diapason.	Quinte 2 2/3 . . . . .	Quint 2 2/3.
Prestant . . . . .	Octave 4'.	Septième . . . . .	Septieme 1 1/7.
Salicet 4 . . . . .	Violina 4'.	Piccolo 1 . . . . .	Piccolo 1'.
Salicional . . . . .	Salicional.	Fourniture . . . . .	Mixture.
Dulciana . . . . .	Dulciana.	Mixtures . . . . .	Mixture.
Gambe . . . . .	Viol di gamba.	Petites mixtures . . . . .	Soft mixture.
Violoncelle . . . . .	Cello.	Anches préparées . . . . .	Used only in french organs.
Soubasse . . . . .	Bourdon 16'.	Boite fermée . . . . .	Swell-box closed.
Contrebasse . . . . .	Diapason 16'.	Boites fermées . . . . .	Swell-boxes closed.
Cor de nuit . . . . .	Gedeckt 8'.	Boite ouverte . . . . .	Swell-box open.
Fonds . . . . .	Foundation stops.	Boites ouvertes . . . . .	Swell-boxes open.
Unda Maris . . . . .	Unda Maris.	Boite mi-ouverte . . . . .	Swell-box half open.
Voix céleste . . . . .	Vox angelica.	Boites mi-ouvertes . . . . .	Swell-boxes half open.
Voix humaine . . . . .	Vox humana.	Octave grave . . . . .	Sub-octave.
Clarinete . . . . .	Clarinet.	Octave aiguë . . . . .	Super-octave.
Cor de basse . . . . .	Corno di bassetto.	M. D. . . . .	Right hand.
		M. G. . . . .	Left hand.

Figure 2. Franck: *Prélude, Fugue and Variation*

GRAND ORGUE	POSITIF	RECIT	PÉDALE	
	Flute 8'	Bourdon 8' Flute 8' Hautbois 8'	Flute 16' Flute 8' Flute 4'	REGISTERS
Fonds 16', 8', 4'	Fonds 16', 8'	Fonds 8', 4' Anches	Fonds 16', 8'	ENSEMBLES
II - I III - I (Fugue)	III - II (Fugue)		Tirasses (Fugue)	ACCOUPLLEMENTS

and arrange them over the several manuals and pedal in the traditional form, just as the various instruments of the orchestra are identified and assembled on stage for performance. In fact, it would seem that Tournemire anticipated such a plan, for he has provided an Index in the preface to his suites of *L'Orgue Mystique* which indicates all the registers he has specified throughout his scores (Figure 1).

To prepare a disposition for such an organ, an open plan with columns representing each of the various manual and pedal divisions may serve to assemble all the registers from the organ scores. These columns may be divided into three parts, with individual registers to be placed in the upper compartment, choruses of registers in the second compartment, and couplers in the lower compartment. By using the Index of Tournemire as his scores are studied, it is possible to confirm in which division each register belongs. After completing these lists, the individual registers which comprise the various choruses or ensembles can be itemized.

Beginning with the larger movements from the symphonies of Widor and Vierne, it is possible to determine first how the foundation stops and mixtures will be assembled on the Grand Orgue, Positif, Récit and Pédale organs. This may be followed by a study of the choruses which comprise the anches or reeds: the bombardes, trompettes and clairons, according to their placement on the various keyboards.

The identification of the various registers, ensembles and couplers can be determined by a study of the various scores in detail with the Index of Tournemire to be used as reference.

We may begin, for example, with one of the various works for organ by César Franck, such as the *Prélude, Fugue and Variation*. For the *Prélude*, we discover that Franck indicates a bourdon 8', flûte 8' and hautbois 8' to be played on the Récit; for the left hand a flûte of 8' to be drawn on the Positif; and in the Pédale flûtes of 16' and 8' pitch. These registers may accordingly be entered in the upper compartments of the master plan (Figure 2). Following the *Prélude* there is a short interlude and now appear indications of registers as a group or ensemble. Here Franck indicates fonds at 8' and 4' on the Récit, fonds 16' and 8' on both the Positif and Grand Orgue and fonds 16' and 8' for the Pédale. These groups may be placed temporarily in the middle compartments of the appropriate columns. All manual and pedal couplers are drawn and these will be placed in the lower compartments. For the *Fugue*, Franck indicates fonds et hautbois 8' on the Récit; fonds de 8' on the Positif; fonds de 8' on the Grand Orgue; and fonds de 8' and 16' for the Pédale. At the beginning of the last line of the *Fugue*, fonds de 16' and its anches on the Récit are to be drawn. At the end of the *Fugue*, the player



SEBASTIAN MATT. GLUCK ORGELBAU  
PIPE ORGAN CONSERVATORS, ARCHITECTS, AND BUILDERS  
175 FIFTH AVENUE  
SUITE 2190  
NEW YORK, NEW YORK 10010  
TELEPHONE (212) 924-4184

Figure 3. Tournemire: *L'Orgue Mystique*, Suite 33, Offertory (page 1)

Figure 4

GRAND ORGUE	POSITIF	RECIT	PÉDALE	
Bourdon 8' Flûte 8'	Bourdon 8' Flûte 8' Unda Maris 8' Gambe 8' Bourdon 16'	Bourdon 8' Flûte 8' Gambe 8' Voix Celeste 8'	Soubasse 16' Bourdon 8'	REGISTRES
				ENSEMBLES
II - I III - I			Tirasses	ACCOUPLLEMENTS

returns to the registration of the Prélude. (Throughout this work dynamic marks refer to use of the Récit louvres, and the player will at his discretion treat the opening and closing of the louvres accordingly.)

We may look further to another example, page 4 from Suite 33 of *L'Orgue Mystique* by Tournemire (Figure 3, the first page of the Offertory), indicating every detail of the registration and expression. As noted, the registration for its performance calls for a bourdon 8', flûte 8', gambe 8' and a voix celeste 8' to be drawn on the Récit; a bourdon 8', flûte 8', unda maris 8' and a gambe 8' on the Positif; a bourdon 8' and flûte 8' on the Grand Orgue; and a soubasse 16' and bourdon 8' for the Pédale. At the beginning of the first line a bracket indicates that all three manuals are to be coupled and that the piece is to be played on the Grand Orgue. There is also an indication that the boxes are to be open (Boîtes ouvertes). At the last measure of line one, the player is reminded that all the pedal couplers are drawn. At the last measure of the second line, the right hand goes to the Positif and, at the vertical dotted line moves again to the Récit. The expression mark at that measure indicates that the boxes will gradually close and by the second measure of line three will be completely closed (Boîtes fermées). Also, at that point, the unda maris will be retired and a bourdon 16' added, and the right hand will play on the Positif. On line four at the second measure the pedal couplers will also be retired. At the last measure the bourdon 16' of the Positif will be retired and the unda maris again added. The bracket and roman numerals I, II and III also tell the player to return to the Grand Orgue with all manual couplers drawn. At this point the boxes are to be opened halfway (Boîtes mi-ouvertes). In Figure 4 we have added on our chart all the registers Tournemire requires for the performance of this work.

Beginning with the larger movements from the symphonies of Widor and Vierne, it is possible to determine first how the foundation stops and mixtures will be assembled on the Grand Orgue, Positif, Récit and Pédale organs. This may be followed by a study of the anches or reeds as they are assembled as choruses—the bombardes, trompettes and clairons according to their placement on the various manuals and pedal. The master chart may appropriately be used for this purpose.

It will obviously be necessary to study a large number of representative scores of Franck, Widor, Vierne, Tournemire, Alain and Messiaen and so gather all the names of the registers and their location within the organ. Once we have accumulated a large and representative number of forms, each containing a list of the necessary registrations for the indicated composition, it will be possible finally to create a disposition for a large three-manual and pedal organ containing all the required registers for the performance of virtually any organ composition composed in France after 1850 (Figure 5).

Figure 5

GRAND ORGUE

- 16' Montre
- 16' Bourdon
- 8' Montre
- 8' Bourdon
- 8' Flûte
- 8' Salicional
- 4' Prestant
- 4' Flûte
- 2 1/2' Quinte
- 2' Doublette
- Plein Jeu
- 16' Bombarde
- 8' Trompette
- 4' Clairon

POSITIF

- 16' Quintaton
- 8' Montre
- 8' Bourdon
- 8' Flûte
- 8' Gambe
- 8' Unda Maris
- 4' Prestant
- 4' Flûte
- 2 1/2' Nasard
- 2' Doublette
- 1 1/2' Tierce
- 1 1/2' Larigot
- 1' Piccolo
- Plein Jeu
- 16' Cor Anglais
- 8' Trompette
- 8' Cromorne
- 4' Clairon
- Tremblant

RÉCIT

- 16' Bourdon
- 8' Bourdon
- 8' Gambe
- 8' Voix Celeste
- 4' Flûte
- 2 1/2' Nasard
- 2' Octavin
- Plein Jeu
- Cymbale
- 16' Basson
- 8' Trompette
- 8' Hautbois
- 8' Voix Humaine
- 4' Clairon
- Tremblant

PÉDALE

- 32' Soubasse
- 16' Contrebasse
- 16' Violon-basse
- 16' Soubasse
- 8' Flûte
- 8' Bourdon
- 8' Violoncelle
- 4' Octave
- 4' Flûte
- 32' Contre-Bombarde
- 16' Bombarde
- 16' Basson
- 8' Trompette
- 4' Clairon

COUPLERS

- Positif to Grand Orgue
- Récit to Grand Orgue
- Octave Grave to Grand Orgue:
  - Grand Orgue
  - Récit
- Récit to Positif
- Octave Grave to Récit
- Tirasses:
  - Grand Orgue
  - Positif
  - Récit

Unlike orchestras, the size of organs is usually determined by the size and acoustics of the rooms in which they are to stand and many other factors, including cost. According to the method described here, the design of the most complete instrument would involve great cost and a large church or hall for its installation. Although this is only occasionally possible, the goal in every case should still remain one which represents an organ designed solely on the basis of registration. In an organ of moderate size, with perhaps 40 registers, it will not be possible to have every specified register to be found within the wide range of French organ music after 1850. Nevertheless, it will be possible to have a complete representation of all the necessary registers. For example, a choice of solo reeds will have to be made; if it is not possible to have an English horn 8', the organist may still have a choice of an hautbois or a clarinet, or a solo register appropriate for a passage designated for the English horn 8'. It will still be possible to have the required montres, prestants and mixtures; the bourdons and flûtes harmoniques; and strings in each manual division. With thought and imagination even smaller organs limited to two manual divisions may still be designed rather successfully on the basis of registration.

The material presented here is little more than an introduction to a unique method for the design of an organ. It is based, of course, on the French organ of Cavallé-Coll and the composers who wrote for it. Nevertheless, it represents a method for organ design which could be extended to embrace a more comprehensive style to include other national styles. Needless to say, much more is required for the design of an organ than a mere list of keyboards and registers. An organ disposition, such as we have presented here, is only a list of stops from which a complete design, with specifications and details of construction can be prepared. To illustrate this method of design, we have only necessarily been limited to a rather narrow study of the French organ and its music. Like the various instruments of the orchestra, the registers of any organ must be re-created by a skillful organ builder to produce a tone and character close to what the composers had in their ears as they conceived the music. Such a builder will also have the ability to scale and construct the pipes in their many forms to re-create all the characteristic registers for the organ he plans. For instance, the flute or the clarinet of the orchestra are well-known. Each has a characteristic tone color, and makers of flutes and clarinets, at their best, faithfully re-create these instruments over and over again. So should we expect the organ builder to re-create the typical registers or "instruments" of the organ, so that the organist will always have available a total instrument on which he can faithfully perform a re-creation of the music written for it. With such an approach to design, a thoughtful organ builder will gradually come to a more realistic understanding of how an organ works in registration, and how the various registers go together successfully in various registrations. Such a builder will also have the knowledge and skill to construct the mechanism for the organ, to include a sensitive key-action representing a coordination of windchests with the voicing of the pipes.

Notes

1. The Tournemire Index may also serve as a translator of the French organ terminology into English. (It will be noted that some of the English terms, as they are used in English speaking countries, are not precisely indicated.)
2. By following such a study as is here outlined, it will soon become evident that the designs of many American organs reveal a lack of essential

- registers. For example, it is the exception to find a string register (gambe or salicional) on the Great, Positif or Choir division of a typical American organ. Also, often missing from the Positif division and the Great divisions (less so) is a trumpet.
3. Franck does not indicate the use of mixtures but intends that they be used together with the reeds (jeux d'anches).

# WALKER

J. W. WALKER & SONS LTD.  
BRANDON · SUFFOLK · ENGLAND

Tracker action organs in the best English tradition

**ALL INQUIRIES FOR WALKER ORGANS & SERVICING  
CALL TOLL-FREE TO ENGLAND: 1-800-628-3275**



BY APPOINTMENT  
TO HER MAJESTY QUEEN ELIZABETH II  
FIVE COLONNATES, AND ROYAL CHAPEL,  
WALKER & SONS LIMITED  
BRANDON SUFFOLK ENGLAND  
ESTABLISHED 1842

# Paul Fritts: An Organ Builder who "Walks the Line" Between Antique and Modern

Herbert L. Huestis

Red is the color of the new organ for Arizona State University and the workmanship and artistry of this instrument are no less stunning than the hue of the case. The polished tin facade pipes gleam with elegance, and hundreds of milled wood parts are exquisitely executed. All this, and Paul Fritts says, "I just want to run an efficient shop, so I can pay my employees a good wage and benefits." A self-effacing way of looking at things is the norm for this Tacoma, Washington, organ builder.

Typical of the challenges that confront a classical organ builder in these times, Paul Fritts walks many a tight rope. He hopes to provide his clients with an organ of exceptional artistic merit, and at the same time, create a comfortable and rewarding working environment for his associates. On top of this, he must obtain the trust of his clients, so he will have a free hand to create an organ of lasting integrity.

And that's only the beginning. For the last fifteen years, Paul Fritts has pursued his dream of organ building in the spirit of the baroque masters, but has forged ahead in today's world, using an arsenal of modern techniques and tools. He states that organ building will never be what it was in the sixteenth, seventeenth or eighteenth centuries, but is now a completely contemporary and up-to-date craft. For him, this is no antiquarian exercise.

He makes the observation that "No matter what kind of organ building you ascribe to, you will follow *some* sort of tradition—my roots are in the past. We have a modern shop; my employees come from ordinary jobs; we use today's power tools and do our drafting with a computer. But I am most comfortable with the antique models, so we base our organs on the work of the old masters."

We continued our tour of the organ at a double-page computer monitor. He deftly called up CAD (computer assisted drafting) files on every aspect of the organ. Pipes, reed shallots, wind system, tracker runs, windchest layouts—they were all there. Yet barely 20 feet away, in contrast to the computer images, we touched beautiful carvings of whimsical cherubs, the richness of the Chinese red case, polished mahogany sliders, quarter-sawn oak pipe racks and marvelously smooth and tactile stop actions. All these elements were coming together like a rising Phoenix on the shop floor—this beautifully sculptured mass of wood and metal would soon utter its first breath.

I asked Paul about the organ's new home.

"The most intriguing aspect of this project for me, is that the room is as carefully designed as the organ. Some ninety feet in length, it is a barrel vaulted chamber that is as historically derived as the organ. It emulates the kind of high-baroque room in which this type of organ was usually found."

He explained that, as always, the acoustical setting would spell the eventual success of an organ. In this case, Professor Robert Clark and the music department of Arizona State University have gone a giant step further and studied the architectural aspects of eighteenth-century rooms as well as the organs themselves. By modeling the organ after Schnitger's masterpiece at the Aa-Kirk in The Netherlands, Fritts was able to make a versatile organ that would play a very large amount of literature with just 28 stops. Since there is a large Skinner organ on the campus as well, they could focus on the design of a baroque organ.

As the project took shape, the university planners gave the organ builder their complete trust. In return, the Fritts Company felt a great responsibility to deliver an organ which embodied the finest craftsmanship the men and

women of the shop could muster. "It's a little bit of a tight-rope, but we try to give the best value we can—and still stay in business," says Paul Fritts. His associates, Charles Ainsley, Ricky Frith, Judy Fritts, Robert Lange, Gordon Porth and Cooper Sherry share these sentiments. Fritts' commitment to the organ building world goes beyond this project. All the scales and data from the new organ are going into a data base that will launch a documentation effort through the American Academy of Organ Building. Paul believes that his artistry is reflected in the voicing of the pipes and doesn't mind sharing the numbers. With this new database, technical aspects of both historical and modern organs will be made available to organ builders, scholars and performers.

Along with the dedication of the new organ, the symposium, "The Historical Organ in America," will be held January 12-16 at Arizona State University. This conference is a presentation of The American Organ Academy, Arizona State University, and The Westfield Center (for information: 602/965-6536; 413/527-7664). Along with the Fritts organ, a number of historically inspired organs will be described and documented. Drawings and scalings will be published in an effort to support the construction of handcrafted mechanical action organs by artisan builders. Hopefully, this will encourage the sharing of information and knowledge, rather than the jealous guarding of organbuilding "secrets."

### Documentation

Nearly all aspects of the organ are thoroughly documented, right down to the smallest details. I was intrigued by some of the pipework, such as the *Viol de Gamba*, which is actually a reed stop, rather than a string. The CAD (computer assisted drafting) drawing is shown below, along with a photograph of the 'C' pipes.

Other drawings and data Paul is submitting for the symposium include:

- Case design
- Windchest and pallet design
- Shallot scales
- Hauptwerk pipe scales
- Unterwerk pipe scales
- Pedal scales

I wanted to know how Paul felt about the organ, as it took shape. He said, "You might say that we're in a state of pre-installation euphoria! There are many aspects of this organ that we feel are the best we've ever done, and certainly we have reached a level of craftsmanship that is very rewarding." After the Symposium at Arizona State is over, they're off to Korea to install an organ that has already been shipped there. Their plate is hardly empty or their cup half-full!

With such a busy schedule there has been little time for reflection. But as we pondered the impact of this new organ, it became obvious that today's artisan builder does a high-wire balancing act between new and ancient expressions of his craft, hand-work and high-tech, security and risk, trust and responsibility. These are the challenges of a modern commitment to authentic organ building.

Those who would follow that star must indeed, "walk the line," just as Paul Fritts does. ■

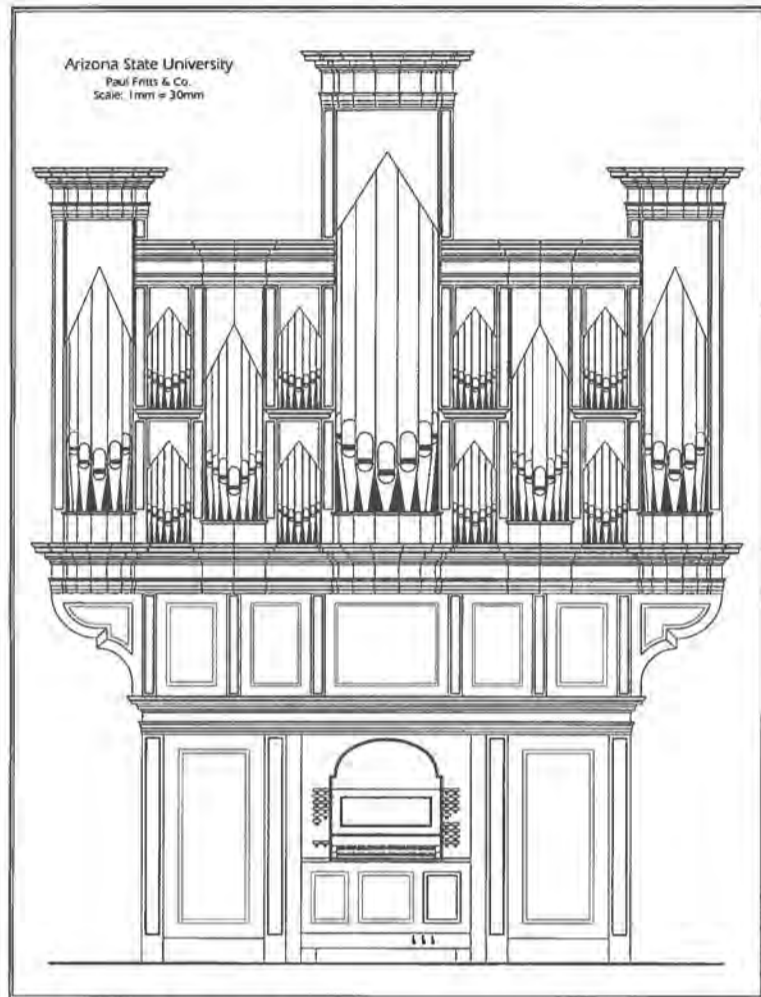

CAD drawing of organ case

Note: CAD (Computer Assisted Drafting) drawings are plotted in full scale, and require few measurements on the drawing. These illustrations are not to scale; therefore the data are incomplete. Full scale drawings are available for study.

### Arizona State University Tempe, AZ

#### Hauptwerk

- 16' Principal
- 8' Octave
- 8' Hohlflöte
- 4' Octave
- 4' Spitzflöte
- 11r Nasat/Cornet
- 2' Octave
- Mixture IV-VI<sup>r</sup>
- 16' Trompet
- 8' Trompet
- 8' *Viol de Gamba* (spelling as in the Alkmaar Schnitger organ)

#### UNTERWERK

- 8' Gedackt
- 4' Principal
- 4' Blockflöte
- 11r Quint/Sesquitarra (note "old style" spelling)
- 2' Gemshorn
- Scharff IV-VI<sup>r</sup>
- 16' Dulcian
- 8' Trichterregal
- 4' Schalmey

#### PEDAL

- 16' Principal†
- 8' Octave\*
- 4' Octave\*
- 2' Nachthorn
- 16' Posaune
- 8' Trompet\*
- 4' Trompet
- 2' Cornet\*

**Couplers:** Unterwerk/Hauptwerk, Hauptwerk/Pedal, Unterwerk/Pedal.

**Other:** Tremulant, Wind Stabilizer.

**Compass:** Manual 58 notes, Pedal 30 notes.

**Casework:** Decorated and ornamented in the manner of 16th and 17th century Ger-

man-Dutch organs. The custom designed case features solid wood construction throughout.

\* Transmissions from other pedal stops.

† Some bass pipes shared with Hauptwerk.

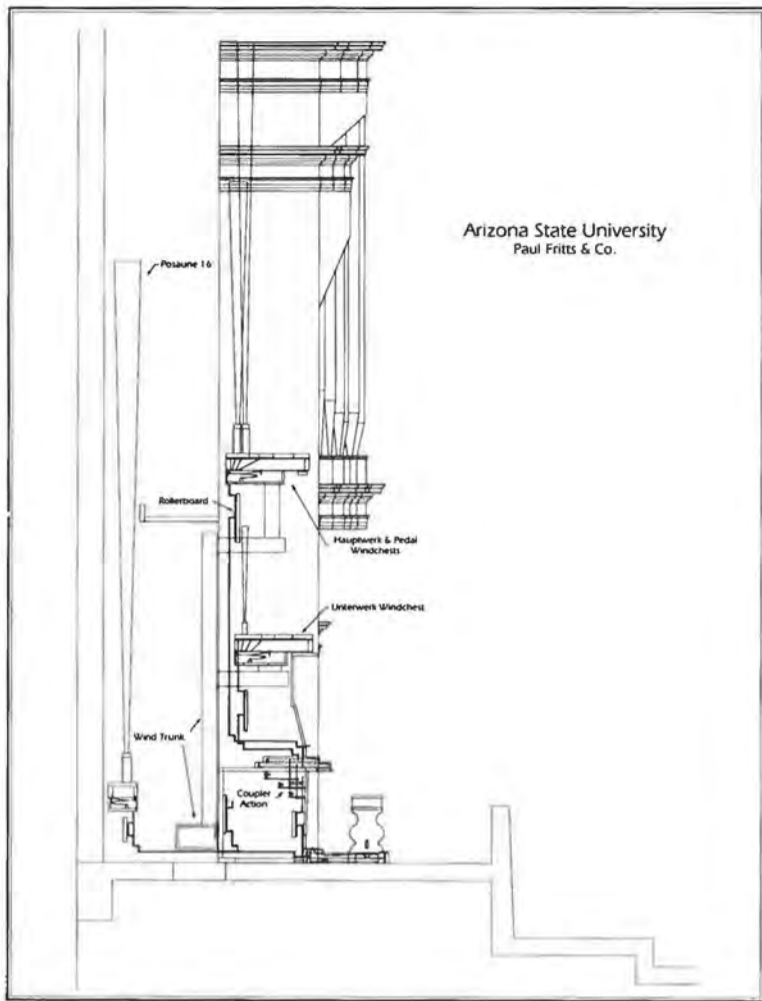

Arizona State University  
Paul Fritts & Co.

Side view

**Opus List**

*As Fritts-Richards Organ Builders:*

1	Shelton, WA	Shelton Methodist Church	1979	2/16*
2A	Shelton, WA	St. David's Episcopal Church	1981	2/8
2B	Tacoma, WA	Residence—David Dahl	1982	2/11
2C	Pasco, WA	Lutheran Church of the Master (owned by Dr. R. Kramer)	1982	2/9
2D	Skillman, NJ	Residence—Joan Lippincott	1982	2/11
3	Olympia, WA	Lutheran Church of the Good Shepherd	1983	2/14
4	Seattle, WA	Saint Alphonsus Parish	1985	2/33
5	San Diego, CA	All Souls' Episcopal Church	1986	3/34
6	Seattle, WA	Gethsemane Lutheran Church	1987	2/27
	Seattle, WA	Residence—Jeff Smith	1988	2/10
	Tacoma, WA	University of Puget Sound	1989	2/34

*As Paul Fritts & Co. Organ Builders*

Seattle, WA	University of Washington	1990	2/22
Korea	Ena R. Jin	1990	2/10
Tempe, AZ	Arizona State University	(1991)	(2/29)
Tacoma, WA	Grace Lutheran Church	(1993)	(2/22)
Tacoma, WA	Pacific Lutheran University	(1994)	(3/44)
Soledad, CA	Residence—Richard Graff	(1995)	(3/30)

\*Manuals/Stops

**Hauptwerk Principal chorus scales (all cut ups are preliminary)**

Principal 16'

83% scraped and burnished tin; ¼ mouth width

Note	Ø	Wall Th.	Cut up
A	169.6	1.5-8	
c <sup>0</sup>	150	1.4-8	30
c <sup>1</sup>	85	1.1-6	19.5
c <sup>2</sup>	49	.6-5	10.5
c <sup>3</sup>	28	.7	6.8
a <sup>3</sup>	18.4	.6	

Octave 2'

30% tin; scraped metal; ¼ mouth width

Note	Ø	Wall Th.	Cut up
C	46.6	8-6	10.5
c <sup>0</sup>	27.3	.6-5	6.8
c <sup>1</sup>	15.9	5-4	4.5
c <sup>2</sup>	9.3	.45	2.9
c <sup>3</sup>	5.5	.4	1.5
a <sup>3</sup>	3.9	.35	

Octave 8'

98% hammered lead

Note	Ø	Wall Th.	Cut up
C	150	1.9-1.2	30
c <sup>0</sup>	85	1.4-1	19.5
c <sup>1</sup>	49	1-8	10.5
c <sup>2</sup>	28	.7	6.8
c <sup>3</sup>	16	.6	4.5
a <sup>3</sup>	10.6	.5	3

Mixture & Scharff scale

30% tin; scraped metal; ¼ mouth width

Pitch	Ø	Wall Th.	Cut up
1 ½'	34.1	.6-5	8
1'	27.3	.6-5	6.8
½'	15.9	5-4	4.5
¼'	9.3	.45	2.9
⅛'	5.5	.4	1.5

Octave 4'

30% tin; scraped metal

Note	Ø	Wall Th.	Cut up
C	85	1.2-8	19.5
c <sup>0</sup>	49	.8-6	10.5
c <sup>1</sup>	28	.6-5	6.8
c <sup>2</sup>	16	5-4	4.5
c <sup>3</sup>	10.6	.45	2.9
a <sup>3</sup>	6.3	.4	1.5

Mixture Composition

C	c <sup>0</sup>	fs <sup>0</sup>	c <sup>1</sup>	c <sup>2</sup>	cs <sup>3</sup>
1	13	19	25	37	50
			4'	4'	4'
		3'	3'	3'	3'
	2'	2'	2'	2'	2'
			2'	2'	2'
1 ½'	1 ½'	1 ½'	1 ½'	1 ½'	1 ½'
1'	1'	1'	1 ½'	1 ½'	
¾'	¾'				
	¾'				
½'					



Paul Fritts and Associates (l to r): Gordon Porth (seated), Charles Ainsley, Ricky Frith, Cooper Sherry, Paul Fritts, Robert Lange (Judy Fritts not shown).



Facade pipes are 75% tin.

Shallot data

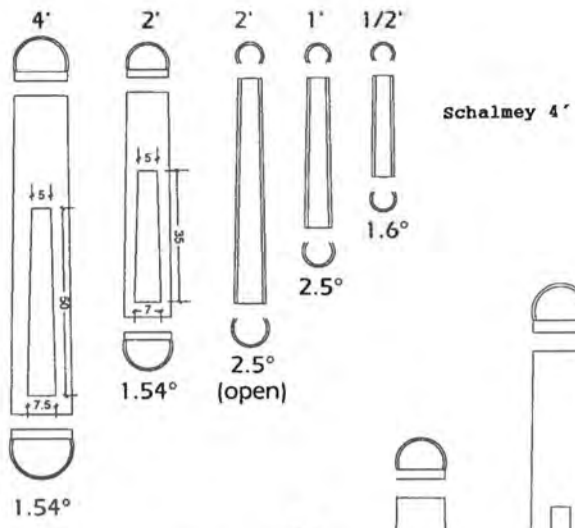

Schalmey 4'

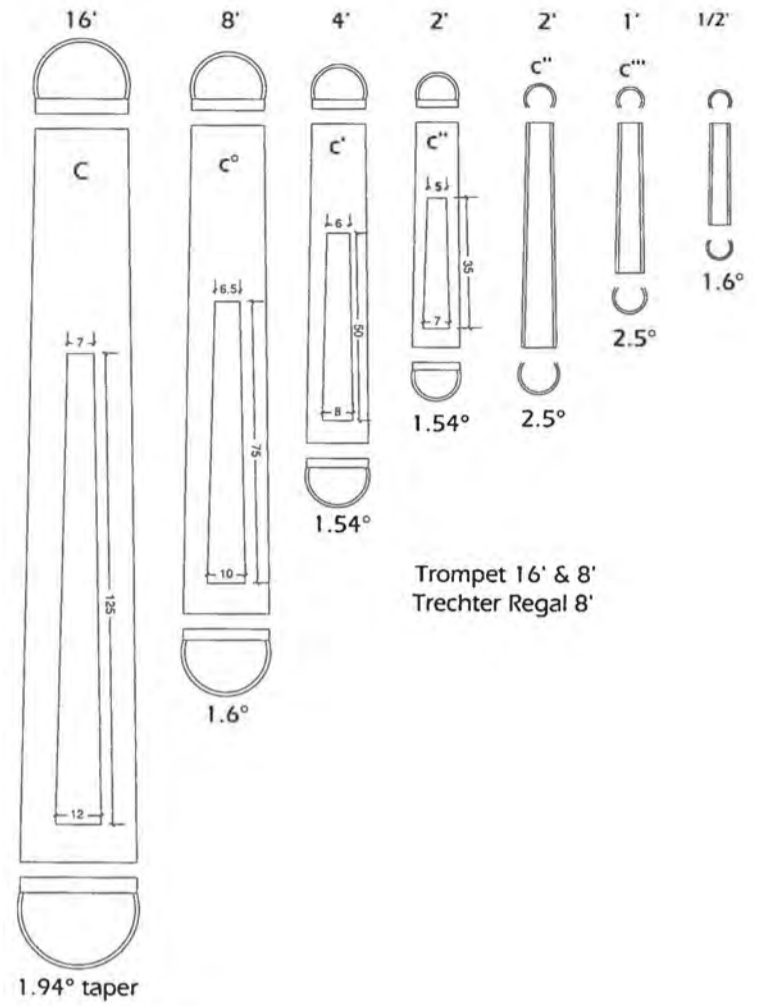

Trompet 16' & 8'  
Trechter Regal 8'

Viool de Gamba 8'

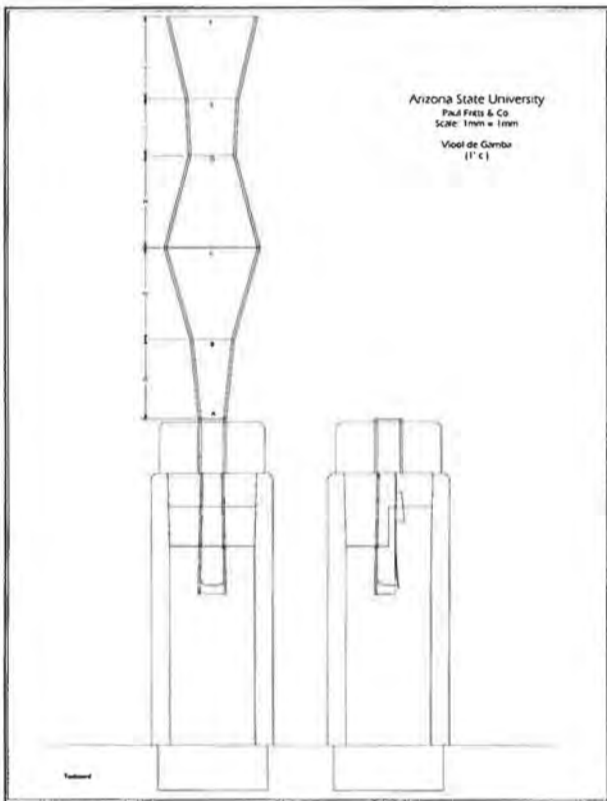
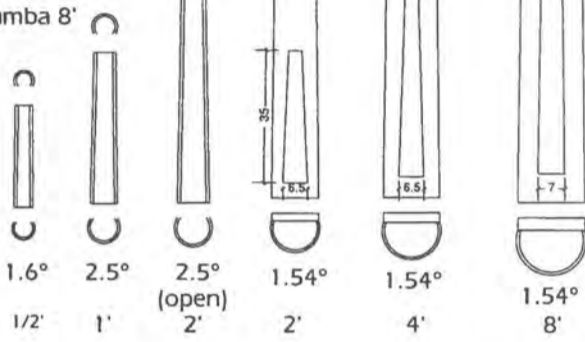

Viool de Gamba



Viool de Gamba pipes



The console inset mirrors the arch of the barrel-vaulted room in which the organ will find its home.

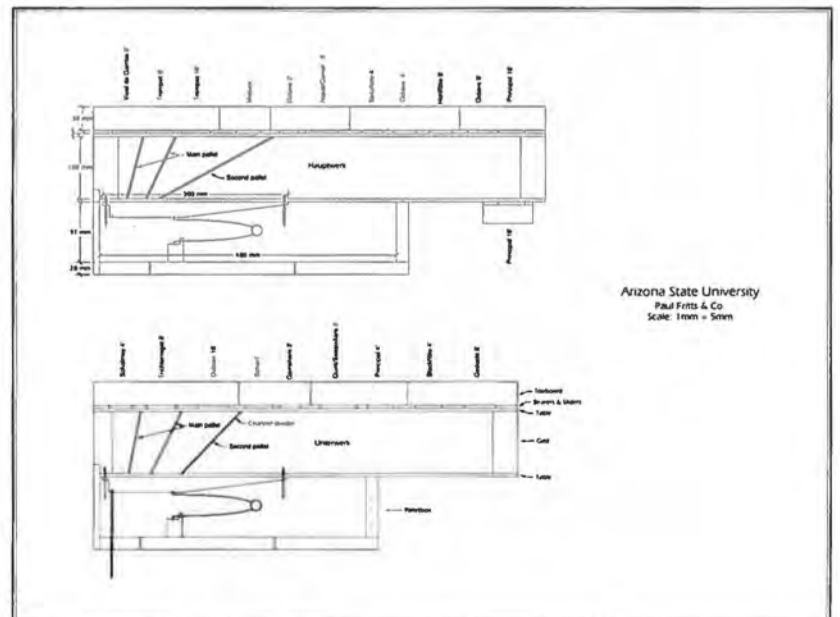

Windchest and pallet design

## Dyer organ for Union College Barbourville, KY

by W. G. Marigold

Randall Dyer and Associates, of Jefferson City, TN, recently completed their Opus 50 for Conway Boatman Chapel at Union College in Barbourville, KY. The organ replaces a Kilgen of about the same size dating from around 1950. That instrument required a great deal of electrical work over the years, and despite rebuilding and enlarging, it was not able to meet the demands placed on it. Since the pipe-work was thoroughly buried behind plaster grilles, the sound did not really fill the large, resonant chapel. In 1989, the Dyer firm, which had cared for the instrument for some 15 years, was given the contract for a new instrument. The result is an interesting and successful attempt to solve a common problem. Funds were extremely limited, yet the organ had to be large enough to fill a 600-seat chapel used for religious services and academic ceremonies, serve as a teaching instrument, and be able to function as a recital and accompanying instrument in a fairly ambitious music program.

### Tonal Resources

- 16' Gemshorn 52 pipes
- 16' Gedackt (1-24 old) 61 pipes
- 8' Principal (in case) 56 pipes
- 8' Celeste (TC-c49) 37 pipes
- 4' Octave 68 pipes
- 4' Rohrflöte 49 pipes
- 2½' Quinte (TC) 49 pipes
- 2' Spitzflöte 49 pipes
- 1¾' Terz (TC-c49) 37 pipes
- III-IV Mixture 184 pipes
- II Zimbel (TC-c49) 74 pipes
- 32' Basson/Hautbois (1-24 electronic) 49 pipes
- 16' Posaune/Trompete 68 pipes
- 16' Bourdon (old) 44 pipes

This yields the following specification:

### Great Organ

- 16' Gemshorn
- 8' Principal
- 8' Gedackt
- 4' Octave
- 4' Rohrflöte
- 2½' Quinte
- 2' Spitzflöte
- 1¾' Terz
- III-IV Mixture
- 8' Trompete

### Swell Organ

- 8' Rohrflöte
- 8' Gemshorn
- 8' Celeste
- 4' Spitzflöte
- 2' Octave
- 1¾' Terz
- 1½' Quinte
- II Zimbel
- 16' Basson
- 8' Hautbois

### Pedal Organ

- 16' Bourdon
- 16' Gedacktbass
- 8' Principal
- 8' Bourdon
- 8' Gemshorn
- 4' Principal
- 32' Basson
- 16' Posaune
- 8' Trompete
- 4' Hautbois

Unison couplers, Tremulant to entire organ. Totally enclosed except for 8' Principal (in case) and 16' Bourdon, for which there was no room in the free-standing case. Accessories: 12 general pistons (thumb and toe pistons); couplers (thumb and toe pistons, reversible); full organ (thumb and toe pistons, reversible). Compass: manuals 56 notes, pedal 32 notes.

The approach used here has been applied by the Dyer company to several organs. Essentially, a rather complete Great Organ is the basis from which everything else is derived. With one exception, a stop playing at one pitch on one manual plays at a different pitch on the other. All stops are independent only at the extreme ends. The pedal relies on the 16' Bourdon, helped by its placement against a masonry wall, to supply body.

The movable console, in French-terraced style, is solid cherry. The "tracker-feel" touch is very comfortable. Electric action, total enclosure, and a tremulant to the whole instrument were necessary to provide the flexibility desired. The Swell Hautbois manages to sound impressive either as part of an "English" full Swell or as a solo stop. The transition to the electronic pedal reed notes is so smooth that it is doubtful whether many organists would notice it at all.

Helped by the new position and aggressive voicing, the new organ sounds a great deal larger than its predecessor. Dyer's tonal director, Bradley Jones, made every stop count and secured fine tone and excellent contrasts in an instrument that seems to fulfill all the demands likely to be made on it. It may be mentioned that in southeast Kentucky, this is probably the only organ in a radius of 50-75 miles capable of giving a good account of itself in a wide-ranging repertory.

The organ was designed by Randall S. Dyer and installed by Mr. Dyer and Mr. Jones. Dr. W. G. Marigold, Professor of German and College Organist, served as consultant for the college and played the dedicatory recital, using works chosen specifically to show off the new organ. ■



A Gift Subscription to

## THE DIAPASON

The perfect Holiday gift for

- + Organist colleagues
- + Students
- + Teachers
- + Choir Directors
- + Organbuilders

Each month your gift will keep giving by providing the important news of the organ and church music field. Send in the form below along with your check and know that your gift will be just right.

### THE DIAPASON

380 NORTHWEST HIGHWAY • DES PLAINES, IL 60016

FOR:	ENCLOSED IS
Name _____	<input type="checkbox"/> \$35.00—3 years
Street _____	<input type="checkbox"/> \$25.00—2 years
City _____	<input type="checkbox"/> \$15.00—1 year
State _____ Zip _____	Foreign subscriptions:
	<input type="checkbox"/> \$58.00—3 years
	<input type="checkbox"/> \$40.00—2 years
	<input type="checkbox"/> \$23.00—1 year
From: _____	

## Organ Leathers

Chrome-Tanned & Certified  
Leathers for Organbuilders,  
From Organbuilders

### Columbia Organ Leathers

915 Lancaster Avenue 1-800-423-7003  
Columbia, PA 17512 717/684-2108  
(outside continental U.S.)

FAX 717/684-4428

# New Organs

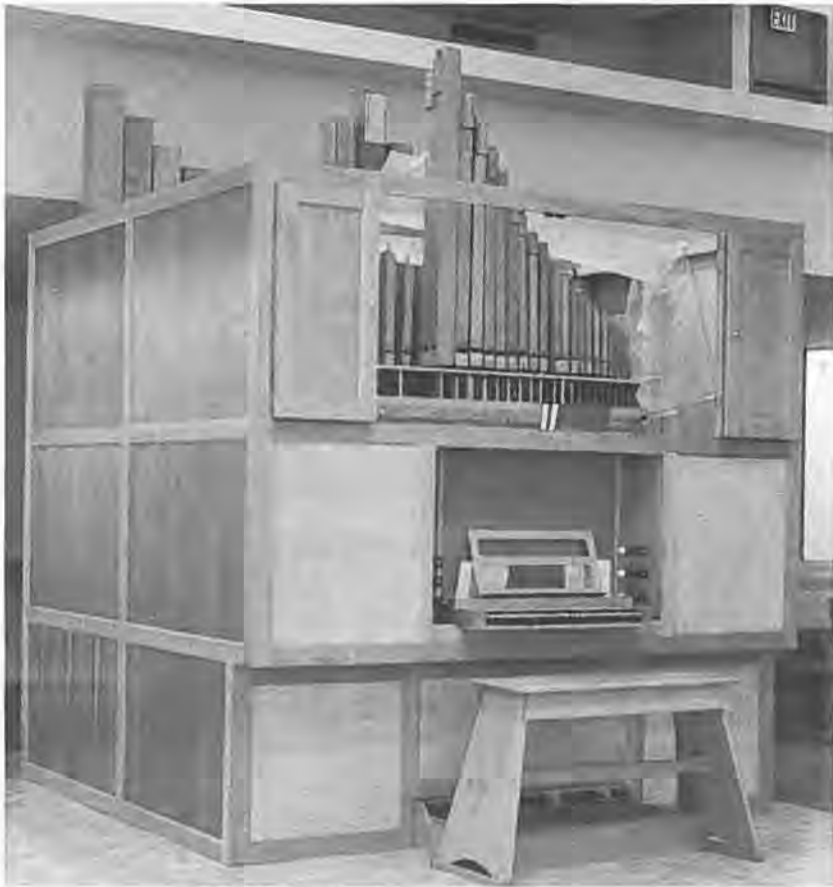

The Grand Rapids, MI, firm of Tyre and Goudzwaard, Inc., has installed its Opus 20 in the University Reformed Church in Ann Arbor, MI. The pipes of this mechanical-action instrument are entirely of oak and operate on a wind pressure of 78 mm. The (currently) three stops of the single manual are distributed over two chests so that the open 8' can couple independently to the pedal. There is also a manual/pedal coupler. The cabinet is of frame and panel oak with a facade of cane. Keyboard 52 notes C-d'', pedal 27 notes C-d' (flat, non-radiating). Tuning is equal temperament, a=440, although the keyboard shifts to low pitch. The entire instrument rests on a wheeled base.

Edward L. Parmentier, Professor of

Early Music and Harpsichord at the University of Michigan School of Music, was accompanied by the URC Choir and Chamber Orchestra (Linda Jones, conductor) at the dedication concert in a performance of Cantata 29 "Wir danken dir, Gott, wir danken dir" by J. S. Bach. Parmentier also performed solo works of Bach, Byrd, and Frescobaldi. Bradley Brookshire, of Cologne, West Germany, former URC organist and consultant on the installation, played works by Georg Boehm, and URC organist Bradley Lehman accompanied choir and orchestra in performances of his arrangements of "When in Our Music God is Glorified" (Stanford) and "New Songs of Celebration Render" (Strasbourg Psalter-1545).

### MANUAL

- 8' Prinzipal
- 4' Blockflöte
- 2' Superoctav
- II Mixtur (prep)

### PEDAL

- 16' Subbass



The Saint Dunstan-Art Organ Works, Houston, TX, has recently completed the relocation and revoicing of the 1967 electric-action Wicks pipe organ number 4724 in St. Mary's Roman Catholic Church, Texas City, TX. This organ was originally built for the Chapel of the St. Anthony Center, a long-term care facility in Houston staffed by the Sisters of Charity of the Incarnate Word. Thomas P. Martin, owner of The Saint Dunstan-Art Organ Works, designed the installation, which necessitated a complete remodeling of the sanctuary. A platform five feet over the main floor and six feet deep was constructed, and the altar was moved forward. The Swell is behind the center section, the Great Gedeckt is exposed on the left, with the 12-pipe extension for the Pedal Subbass behind. The Great Principal is exposed on the right side. The Saint Dunstan-Art Organ Works constructed a new chest frame

for the Great Principal, which originally shared a chest with the Gedeckt. It was necessary for the entire organ to be completely revoiced. The wind pressures were raised throughout from 2½" to 4½". All labial pipework was thoroughly nicked to provide a consistently prompt but non-percussive attack. The level of the Gemshorn was raised from barely audible to that of a Spitzprincipal. The Fagot was revoiced into a Trumpet.

The dedicatory recital was performed April 28, 1991 by organist Anna Marie Flusche, O.P., who had practiced for many years on the organ in its original installation. She was assisted by soprano Margaret Schwender Stenborg, trumpeter Willie Strieder, and violinist Kris Kelly. Father Paul Chovanez is pastor of St. Mary's, Pat Lamp is the music director, and Docia Woytek is organist.

### GREAT

- 8' Gedeckt
- 8' Gemshorn (Sw)
- 4' Principal
- 4' Rohrflöte (Sw)
- 2' Octave
- II Mixture (Sw)
- 8' Fagot (Sw)

### SWELL

- 8' Rohrflöte
- 8' Gemshorn
- 4' Gemshorn
- 2½' Nazard
- 2' Blockflöte
- 1½' Spitz Quint
- 8' Fagot
- Tremolo

### PEDAL

- 16' Subbass
- 8' Rohrflöte (Sw)
- 4' Choral Bass (Ct)
- 4' Fagot (Sw)



Petty-Madden Organbuilders, Inc., Hopewell, NJ, has built a new organ for the Church of St. Joseph of Arimathea (Episcopal) in Elmsford, NY. The chapel (now church) was commissioned by Sara Newton Worthington sometime after the death of her husband, Henry Rossiter Worthington, in December of 1880. The family chapel, which contained a burial crypt underneath the chancel and sanctuary, was completed in 1883. Two years after Mrs. Worthington's death in 1893, the family conveyed the chapel to the Episcopal Diocese of New York. Over time the parish grew considerably and in 1953 a small parish house was built onto the chapel. There were four instruments in the chapel between 1928 and 1990: two reed organs, an electronic organ, and a pipe organ built by a midwestern company. In 1990 the parish renovated and expanded the parish house, refurbished the chapel and commissioned the new organ.



The firm's opus 30 is located on a platform between the last two rear roof trusses of the nave. Even though the organ is encased, only an 8' facade is visible in order to keep the organ visually balanced within the exceedingly small chapel. Acoustically transparent cloth, which to the eye appears to be plaster, masks the remainder of the instrument. The polished 8' Principal in facade is made of 40% tin-60% lead and arranged in two lateral flats separated by a central tower. The generously-scaled pipes stand on slider wind chests and speak on 50 (manuals) to 75 (pedal) mm wind pressure. With the exception of the Subbass and the lowest pipes of the Metal Gedeckt, all pipes are made of tin-lead alloy with lead predominating. The movable console is located in a chancel alcove near the choir; console and case are made of mahogany; ebony-wood drawknobs are arranged on terraced stop jambs to the left and right of the keyboards; compass is 56/32.

### GREAT

- 8' Principal
- 8' Metal Gedeckt
- 4' Octave
- 2' Mixture IV
- 8' Trumpet
- Tremulant

### SWELL

- 8' Gemshorn
- 8' Gemshorn Celeste (TC)
- 4' Koppel Flute
- 2½' Nazard
- 2' Principal
- 1½' Tierce
- Tremulant

### PEDAL

- 16' Subbass
- 8' Gedeckt Bass (ext)
- 16' Still Posaune

# Calendar

This calendar runs from the 15th of the month of issue through the following month. The deadline is the first of the preceding month (Jan 1 for Feb issue). All events are assumed to be organ recitals unless otherwise indicated and are grouped within each date north-south and east-west. \* = AGO chapter event, \*\* = RCCO centre event, + = new organ dedication, ++ = OHS event.

Information cannot be accepted unless it specifies artist name, date, location, and hour in writing. Multiple listings should be in chronological order, please do not send duplicate listings. THE DIAPASON regrets that it cannot assume responsibility for the accuracy of calendar entries.

## UNITED STATES East of the Mississippi

### 15 DECEMBER

Handel, *Messiah*; Trinity Church, Boston, MA 7 pm

Honneger, *A Christmas Cantata*; First Church of Christ, Wethersfield, CT 4, 7 pm

Respighi, *Lauda per la Nativita*; St Thomas Seminary, Bloomfield, CT 4 pm

Lorenz Maycher; First Church of Christ, Scientist, New York, NY 1:30 pm

Frederick Grimes and *Magnificat* (Bach); Holy Trinity Lutheran, New York, NY 5 pm

A Jazz Nativity; St Bartholomew's, New York, NY 8 pm

Choral Concert; Church of the Good Shepherd, New York, NY 4 pm

Christmas on Logan Square, Philadelphia Singers; St Clement's, Philadelphia, PA 2:30, 4:15 pm

American Boychoir; St George Episcopal, Ardmore, PA

Lessons & Carols; First Presbyterian, Burlington, NC

Wilmington Boys Choir; St Paul's Episcopal, Wilmington, NC 4 pm

Karel Paukert; Cleveland Museum of Art, Cleveland, OH 2 pm

Play of Daniel; St John's Cathedral, Milwaukee, WI 2:30 pm

Music of Christmas; First Presbyterian, Deerfield, IL 4:30 pm

Saint-Saëns, *Christmas Oratorio*; Park Ridge Community Church, Park Ridge, IL 10:30 am

His Majesty's Clerks; Quigley Chapel, Chicago, IL 2:30 pm

Wolfgang Rübsum; Rockefeller Chapel, Chicago, IL 8 pm

Edward Zimmerman; St Mark's, Glen Ellyn, IL 4 pm

Lessons & Carols; Christ Church Cathedral, New Orleans, LA 4 pm

16 DECEMBER

Christmas Concert; Church of the Advent, Boston, MA 7:30 pm

Phillips, *Bending Towards the Light*; St Bartholomew's, New York, NY 8 pm

17 DECEMBER

Ray Cornils, with brass; City Hall, Portland, ME 7:30 pm

Handel, *Messiah*; St Thomas, New York, NY 7:30 pm (also Dec 19)

18 DECEMBER

Community Carol Sing; St Thomas, New York, NY 12:10 pm

U.S. Air Force Camerata; St John's, Washington, DC 12:10 pm

20 DECEMBER

Brian Jones; Trinity Church, Boston, MA 12:15 pm

New England Youth Orch and Atlantic Union College Choir with John Rutter; St Bartholomew's, New York, NY 8 pm

American Boychoir; Trinity Cathedral, Trenton, NJ 8 pm

### 21 DECEMBER

American Boychoir; Richardson Auditorium, Princeton Univ, Princeton, NJ 8 pm

His Majesty's Clerks; St Procopius Abbey, Lisle, IL 8 pm

### 22 DECEMBER

Lessons & Carols; South Church, New Britain, CT 4 pm

Lessons & Carols; St Thomas, New York, NY 11 am & 4 pm

David McK Williams, *Pageant of the Holy Nativity*; St Bartholomew's, New York, NY 4 pm

Candlelight Carol Services; Holy Trinity Lutheran, New York, NY 5, 7:30 pm

American Boychoir; Brooklyn College, Brooklyn, NY 2 pm

Handel, *Messiah*, with orchestra; First Presbyterian, Red Bank, NJ 7:30 pm

Singing Boys of Pennsylvania; Muhlenberg Chapel, Allentown, PA 3 pm

Lessons & Carols; St John's, Washington, DC 11 am

Bach, *Cantata 140*, Holst, *Christmas Day*; First Baptist, Kingston, NC 7 pm

Ryba, *Christmas Mass*; Cleveland Museum of Art, Cleveland, OH 2 pm

Mozart, *Dixit et Magnificat*, Vivaldi, *Gloria*; Independent Presbyterian, Birmingham, AL 5 pm

24 DECEMBER

Nine Lessons & Carols; Independent Presbyterian, Birmingham, AL 4 & 6 pm

27 DECEMBER

Eric Hallein; Trinity Church, Boston, MA 12:15 pm

29 DECEMBER

Lessons & Carols; St Bartholomew's, New York, NY 4 pm

Frederick Grimes and *Cantata 28* (Bach); Holy Trinity Lutheran, New York, NY 5 pm

Lessons & Carols; Grace Episcopal, Silver Spring, MD 10:15 pm

Karel Paukert; Cleveland Museum of Art, Cleveland, OH 2 pm

31 DECEMBER

Lessons & Carols; Church of the Advent, Boston, MA 6 pm

3 JANUARY

Daniel Lamoureux; Trinity Church, Boston, MA 12:15 pm

John Rose, with orchestra; Philharmonic Center, Naples, FL 8 pm (also January 4)

5 JANUARY

Bach, *Cantata 65*; Holy Trinity Lutheran, New York, NY 5 pm

Thomas Bara; St Thomas, New York, NY 5:15 pm

Elizabeth Melcher, John Sittard; Longwood Gardens, Kennett Square, PA 2:30 pm

Singing Boys of Pennsylvania; First Presbyterian, Bonita Springs, FL

Karel Paukert; Cleveland Museum, Cleveland, OH 2 pm

Epiphany Feast of Lights; Cathedral Church of the Advent, Birmingham, AL 6:30 pm

6 JANUARY

Harold Stover; St Mary the Virgin, New York, NY 5:30 pm

Torke, *Mass*; St Mary the Virgin, New York, NY 6 pm

Lessons & Carols; Wittenberg University, Springfield, OH 8 pm

8 JANUARY

Samuel Carabatta; St John's Church, Washington, DC 12:10 pm

10 JANUARY

Glenn Kime; Trinity Church, Boston, MA 12:15 pm

11 JANUARY

Gerre Hancock, improvisation workshop; First Presbyterian, Ft Lauderdale, FL 10 am

## robert anderson

SMD FAGO

Southern Methodist University

Dallas, Texas 75275

## WILLIAM AYLESWORTH

D. M.

Evanston, Illinois

## Your Professional Card

could appear in this space

Please write for rates

## GEORGE W. DECKER

St. Paul's Cathedral  
Syracuse, NY 13202

## STEVEN EGLER

Central Michigan University  
First Presbyterian Church  
Mt. Pleasant, Michigan 48858

SOLO Shelly-Egler  
RECITALS Flute and Organ Duo

## GEORGE ESTEVEZ

ch.m.

Chicago Chamber Choir

## ELLEN KURTZ

## FUNK

M.Mus. A.A.G.O.  
Concord, California

## Robert Glasgow

School of Music  
University of Michigan  
Ann Arbor

## BRUCE GUSTAFSON

Franklin and Marshall College  
Lancaster, Pennsylvania

## JAMES HAMMANN

D.M.A. A.A.G.O.

Jefferson Ave  
Presbyterian Church  
Detroit  
Allen Park Symphony

## CHARLOTTE AND WILLIAM ATKINSON

FIRST PRESBYTERIAN CHURCH  
2001 El Camino Real  
Oceanside, California 92054

## ROBERT CLARK

School of Music

ARIZONA STATE UNIVERSITY  
TEMPE, ARIZONA 85281

## WALLACE M. COURSEN JR.

F.A.G.O.

Holy Trinity Episcopal Church  
West Orange, NJ 07052

## RANDALL EGAN

Organist—Editor & Publisher  
"Canadian Repertoire"

c/o The Kenwood Artists' Agency, Ltd.  
2024 Kenwood Pkwy.  
Minneapolis, MN 55405

## KATHRYN ESKEY

The University of  
North Carolina

at Greensboro

## JOHN FENSTERMAKER

GRACE CATHEDRAL  
SAN FRANCISCO

John M. Gearhart III  
B.A., M.Mus.

St. Paul's Episcopal Church  
P.O. Box 8427  
Mobile, Alabama 36608

## Antone Godding

School of Music  
Bishop W. Angie Smith Chapel  
Oklahoma City University

## FREDRICK GUZASKI

Boston, MA

## DAVID S. HARRIS

Organ Consultant  
1332 Del Mar Parkway  
Aurora, CO 80010

## A two-inch Professional Card in THE DIAPASON

Please write for rates  
380 Northwest Highway  
Des Plaines, IL 60016

## PHILIP CROZIER

RECITALIST

4702 Queen Mary Road, Apt 10  
Montreal, H3W 1W8, P. Quebec  
(514) 739-8696

St. James United Church, Montreal  
Temple Emanu-El Beth Sholom, Montreal  
Also Organ Duo concerts with Sylvie Poirier

Gruenstein Award Sponsor

CHICAGO  
CLUB OF  
WOMEN  
ORGANISTS

Hellen M. Callahan, President

Founded 1928

**WILL HEADLEE**  
SCHOOL OF MUSIC  
SYRACUSE UNIVERSITY  
SYRACUSE, NY 13244-1010

**Harry H. Huber**

D. Mus.  
Kansas Wesleyan University, Emeritus  
University Methodist Church  
SALINA, KANSAS

**MICHELE JOHNS**

A.Mus.D  
Organ — Harpsichord  
The University of Michigan  
School of Music

**KIM R. KASLING**

D.M.A.  
St. John's University  
Collegeville, MN 56321

**GALE KRAMER**

DMA  
Wayne State University  
Metropolitan Methodist Church  
Detroit 48202

**RICHARD W. LITTERST**  
**M. S. M.**

SECOND CONGREGATIONAL CHURCH  
ROCKFORD, ILLINOIS

**BETTY LOUISE LUMBY**

DSM • FAGO  
UNIVERSITY OF MONTEVALLO  
MONTEVALLO, ALA. 35115



*Sue Mitchell-Wallace*  
A.S.C.A.P.  
FELLOW, AMERICAN GUILD OF ORGANISTS  
345 SADDLE LAKE DRIVE  
ROSWELL, ATLANTA, GEORGIA 30076  
(404) 594-0949

A two-inch Professional Card  
in

**THE DIAPASON**

Please write for rates  
380 Northwest Highway  
Des Plaines, IL 60016

**MARILYN MASON**

CHAIRMAN, DEPARTMENT OF ORGAN  
UNIVERSITY OF MICHIGAN  
ANN ARBOR

"... Ginastera's... was by all odds the most exciting... and Marilyn Mason played it with awesome technique and a thrilling command of its daring writing."

*The American Organist*, 1980

**MICHAEL GAILIT**

Organist—Pianist



HOCHSCHULE FÜR MUSIK  
Lothringerstrasse 18  
A-1030 VIENNA, AUSTRIA

**VICTOR HILL**

Harpsichord and Organ  
Williams College  
St. John's Episcopal Church  
Williamstown, Mass. 01267

**FRANK IACINO**

St. Elizabeth's Church  
5324 Bromley Rd.  
Burlington, Canada  
Recitals Records

**Brian Jones**

TRINITY CHURCH  
BOSTON

**JAMES KIBBIE**

D.M.A.  
The University of Michigan  
School of Music  
Ann Arbor, MI 48109

**WILLIAM KUHLMAN**

Decorah, Iowa 52101  
Luther College

**David Lowry**

School of Music  
Winthrop College  
Rock Hill, South Carolina 29733

**DAVID McCAIN**

ORLANDO

**WILLIAM H. MURRAY**

Mus. M.F.A.G.O.  
St. John's Episcopal Church  
215 North Sixth Street  
P.O. Box 1432  
Fort Smith, Arkansas 72902

**DAVID GOODING**

St. Peter's Episcopal Church

18001 Detroit Avenue  
Lakewood, OH 44107

12 JANUARY

**Donald Williams**; St Paul's School, Concord, NH 7:30 pm  
**John Sittard**; St Thomas, New York, NY 5:15 pm  
**Peter Conte**; Longwood Gardens, Kennett Square, PA 2:30 pm  
**Elizabeth & Raymond Chenault**; Calvary Church, Charlotte, NC 7:45 pm  
**Gerre & Judith Hancock**; First Presbyterian, Ft Lauderdale, FL 7:30 pm  
**Karel Paukert**; Cleveland Museum, Cleveland, OH 2 pm  
Birmingham Baroque; Independent Presbyterian, Birmingham, AL 4 pm

13 JANUARY

**Michael Murray**, masterclass; Broad Street Presbyterian, Columbus, OH 8 pm

14 JANUARY

Ukrainian Choral Concert; First Church of Christ, Hartford, CT 12:15 pm

15 JANUARY

American Boychoir, with orchestra; Avery Fisher Hall, New York, NY 8 pm  
**Scott Turkington**; St John's Church, Washington, DC 12:10 pm

17 JANUARY

**Brian Jones**; Trinity Church, Boston, MA 12:15 pm  
**Huw Lewis**, workshop; Cathedral Church of the Advent, Birmingham, AL 7 pm

18 JANUARY

**Frederick Swann**, workshop; First Presbyterian, St Petersburg, FL 2 pm  
**John Walker**; Antioch Lutheran, Farmington Hills, MI 7:30 pm  
Hymn Festival; Cathedral Church of the Advent, Birmingham, AL 2 pm

19 JANUARY

**Thomas Trotter**; First Presbyterian, Glens Falls, NY  
**Brenda Leach**; St Thomas, New York, NY 5:15 pm  
+ **Jon Gillock**; Redeemer Lutheran, Ramsey, NJ 4 pm  
**Cj Sambach**; First Presbyterian, Red Bank, NJ 4 pm

Organ & Brass; Grace Episcopal, Silver Spring, MD 7 pm  
Singing Boys of Pennsylvania; St Paul's Lutheran, Washington, DC  
**Calvert Johnson**; Duke Univ, Durham, NC 5 pm

**Frederick Swann**; First Presbyterian, St Petersburg, FL 8 pm  
**Grethe Krogh**; Cleveland Museum, Cleveland, OH 2 pm  
**Robert Poovey**; St Mark's, Glen Ellyn, IL 4 pm  
**Michael Kaminski**; Christ Church Cathedral, New Orleans, LA 4 pm

20 JANUARY

**John Walker**; Bridgewater College, Bridgewater, VA 8 pm

21 JANUARY

**Karl Moyer**; Union Lutheran, York, PA 7:30 pm  
**Richard Heschke**; Christ Church, Pensacola, FL 7:30 pm

22 JANUARY

**Russell Patterson**; St John's Church, Washington, DC 12:10 pm

24 JANUARY

**James Cochran**; Trinity Church, Boston, MA 12:15 pm

26 JANUARY

**Karl Moyer**; St Thomas, New York, NY 5:15 pm  
American Boychoir, with orchestra; Princeton Univ, Princeton, NJ 3 pm  
**Michael Stairs, Kerry Dietz**; Longwood Gardens, Kennett Square, PA 2:30 pm  
**Karel Paukert**; Cleveland Museum, Cleveland, OH 2 pm

28 JANUARY

Choral concert; First Church of Christ, Hartford, CT 12:15 pm  
**Victor Hill**; All Saints, Atlanta, GA 7:30 pm

29 JANUARY

**Scott Reas**; St John's Church, Washington, DC 12:10 pm  
**Kel Koito**; Philharmonic Center, Naples, FL 8 pm

31 JANUARY

**Haskell Thomson**; Trinity Church, Boston, MA 12:15 pm  
**Marilyn Keiser**; Pioneer Memorial, Berrien Springs, MI 7:30 pm

UNITED STATES  
West of the Mississippi

15 DECEMBER

**Delbert Disselhorst**; Klapp Hall, Univ of Iowa, Iowa City, IA 8 pm  
Lessons & Carols; St Stephen Presbyterian, Ft Worth, TX 6 pm  
Christmas Concert; Grace Cathedral, San Francisco, CA 4 pm (also Dec 18, 21 & 22)  
**Charles McDermott**; Trinity Episcopal, Santa Barbara, CA 3:30 pm

21 DECEMBER

Phoenix Bach Choir; Brophy Chapel, Phoenix, AZ 4 & 6 pm (also Dec 22, Chandler Center, 7 pm)

22 DECEMBER

**David Gell**; Trinity Episcopal, Santa Barbara, CA 3:30 pm

7 JANUARY

Singing Boys of Pennsylvania; Friedens UCC, Geronimo, TX

10 JANUARY

**Simon Preston**; Wooddale Church, Eden Prairie, MN  
**Thomas Murray**; St Mark's Cathedral, Seattle, WA 8 pm

12 JANUARY

Singing Boys of Pennsylvania; Oklahoma Central State Univ, Edmond, OK

13 JANUARY

Singing Boys of Pennsylvania; Arts Center, Springdale, AR  
**Guy Bovet**; Arizona State Univ, Tempe, AZ

17 JANUARY

**Michael Murray**; St Paul's United Methodist, Houston, TX 8 pm  
**James Higdon**; St John's Cathedral, Spokane, WA 8 pm

19 JANUARY

**David Higgs**; First Presbyterian, San Diego, CA

20 JANUARY

**Michael Gailit**, all-Reubke; Univ of Redlands, Redlands, CA

21 JANUARY

**Delores Bruch**; Presbyterian Church, Mt Pleasant, IA 7:30 pm  
**Robert Parkins**; Univ of Redlands, Redlands, CA 3:30 pm

24 JANUARY

**David Craighead**; Trinity Univ, San Antonio, TX 8 pm  
**Clay Christiansen**; First Congregational, Los Angeles, CA 8 pm

26 JANUARY

**David Higgs**; Sunnyside Seventh-Day Adventist, Portland, OR

31 JANUARY

**Gerre Hancock**; St Luke's Episcopal, Monrovia, CA

**BRENDA LYNNE LEACH**  
Doctor of Musical Arts  
Premier Prix de Virtuosité

Harvard University  
Adjunct Faculty



Clark University  
Adjunct Faculty

Director of Music & Creative Arts  
Church of the Covenant  
67 Newbury Street  
Boston, MA 02116  
H 617/723-5087 W 617/266-7480

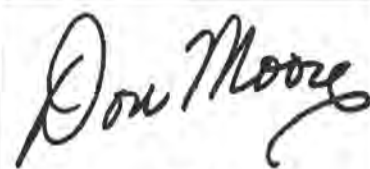

ASCAP  
ORGANIST-CHOIRMASTER  
THE PILGRIM UNITED CHURCH  
OF CHRIST  
130 BROAD BLVD.  
CUYAHOGA FALLS, OHIO 44221

**INTERNATIONAL**

11 JANUARY

**John Tuttle**; Central United, Sault Ste Marie, Ontario 8 pm

17 JANUARY

Shelly-Egler Duo; All Saints Church, Winnipeg, Manitoba 7:30 pm

18 JANUARY

Shelly-Egler Duo, workshop; All Saints Church, Winnipeg, Manitoba 10 am

21 JANUARY

**Kevin Bowyer**; Performing Arts Centre, Calgary, Alberta 8 pm

**Organ Recitals**

**DAVID CRAIGHEAD**, Fourth Presbyterian Church, Chicago, IL, September 29: *Choral No. 1 in E Major*, Franck; *Three Nocturnes*, Delamarter; *Comes Autumn Time*, Sowerby; *Metamorphosis*, Simmons; *Allein Gott in der Höh' sei Ehr*, S. 662, *Toccata and Fugue in F*, S. 540, Bach; *Adagio*, Final (*Symphony No. 6*, op. 59), Vienne.

**CATHARINE CROZIER**, Grace and Holy Trinity Cathedral, Kansas City, MO, September 27: *Praeludium in G Minor*, BuxWV 149, Buxtehude; *Comest Thou, Jesu, from Heaven to Earth*, S. 650, *All glory be to God on high*, S. 662, *Kyrie, God, the Holy Ghost*, S. 671, Bach; *Suite in D*, du Mage; *The Despair and Agony of Duchau*, Siffer; *Ave Maria, Ave Maris Stella*, Langlais; *Canon in B Minor*, Schumann; *Prelude and Fugue on BACH*, Liszt.

**ROBERT DELCAMP**, The University of the South, Seawee, TN, July 19: *Toccata and Fugue in D Minor*, Bach; *Grand Pièce Symphonique*, Franck; *Dialogue on the Mixtures*, Langlais; *Rondo for the Flute Stop*, Rinck; *Adagio for Strings*, Barber; *Tuba Tune*, Lang; *Choral-Improvisation on 'In dulci jubilo'*, Karg-Elert.

**MATTHEW DIRST**, Augustana College Chapel, Sioux Falls, SD, June 19: *Sonata in F Major*, Wq. 70/3, C.P.E. Bach; *Deux*

*Dances a Agni Yavishtha*, Alain; *Concerto in D Minor*, S. 596, Bach; *Canon in A-flat*, *Sketch in D-flat*, Schumann; *Passacaille*, Martin.

**MICHAEL FARRIS**, Northpark Presbyterian Church, Dallas, TX, June 4: *Toccata, Adagio and Fugue*, S. 654, *By the waters of Babylon*, S. 653, *Trio Sonata VI*, S. 530, *Prelude and Fugue*, S. 532, Bach; *Praeludium E Minor*, Bruhns; *Cantabile, Pièce Héroïque*, Franck; *Prelude and Fugue on BACH*, Liszt.

**STEVEN GENTILE**, First Lutheran Church, Alexandria, MN, July 13: *A mighty fortress*, Bender; *O God thou faithful God*, Bach; *Rondo-Scherzo*, Nosetti; *Petite Suite*, *Trumpet Tune*, McCabe; *Canzonetta*, Buxtehude; *Prelude and Fugue in G Major*, S. 550, Bach; *My heart abounds with pleasure*, *Deck thyself my soul with gladness*, *Blessed ye who live in faith unswerving*, *O God thou faithful God*, Brahms; *All glory, laud and honor*, Burkhardt.

**MARNIE GIESBRECHT**, West End Christian Reformed Church, Edmonton, Alberta, May 10: *Prelude, Fugue and Chaconne in C*, Buxtehude; *Sonatine for Pedals Alone*, op. 11, Persichetti; *Fantasia in F Minor*, K. 594, Mozart; *Prelude and Fugue in B Minor*, S. 544, Bach; *Dieu parmi nous*, Messiaen; *Andante in F Major*, K. 616, Mozart; *Finale (Symphony VI)*, op. 59, Vienne.

**JOHN GOUWENS**, Methuen Memorial Hall, Methuen, MA, August 14: *Grand Dialogue*, Marchand; *Méditation (Trois Improvisations)*, Vienne/Duruffé; *Fugue (Symphony I)*, Vienne; *Prelude on 'I am sol recedit igneus'*, Simonds; *Improvisation on a submitted theme: Symphonie Romane*, op. 73, Widor.

**RUTH ANN HAGGLUND**, Trinity Lutheran Church, Silverton, OR, July 19: *Rigaudon*, Campra; *Trio Sonata No. 1 in E-flat*, *Wachet auf, Liebster Jesu wir sind hier*, Bach; *Toccata and Fugue in F Major*, Buxtehude; *Pastorale*, Kuchar; *Schoenster Herr Jesu*, Schroeder; *Finale (Symphony IV)*, Widor.

**EUGENE W. HANCOCK**, Marienkirche, Berlin, Germany, August 10: *Go down Moses, Yoruba Lament*, Sowande; *Homage an HDT und JSB*, Simson; *Orgel-suite I*, Kay; *Impromptu I in F*, Taylor; *We are our heavenly Father's children*, *The Lord will make a way*, Sexton; *Toccata III*, Bankole.

**LEON NELSON**

THE MOODY CHURCH  
CHICAGO, IL 60614

FIRST PRESBYTERIAN CHURCH  
DEERFIELD, IL 60015

**DUDLEY OAKES**  
D.M.A.

Thiel College  
75 College Avenue  
Music Department  
Greenville, PA 16125

**KATHARINE PARDEE**

HENDRICKS CHAPEL  
SYRACUSE UNIVERSITY

**RICHARD M. PEEK**

Sac. Mus. Doc.

Covenant Presbyterian Church  
1000 E. Morehead Charlotte, N. C.

**JOHN DAVID PETERSON**

Memphis State University  
Memphis, Tennessee

**DOUGLAS REED**

UNIVERSITY OF EVANSVILLE  
EVANSVILLE, INDIANA

**STEPHEN G. SCHAEFFER**  
D.M.A.

The Cathedral Church  
of the Advent  
Birmingham, Alabama 35203

**Dennis Schmidt**

A. Mus. D.

St. Paul's School  
Concord, NH 03301

**LARRY SCHOU**

D.M.A.

The University of  
South Dakota  
Music Department  
Vermillion, SD 57069-2390

**Robert Shepher**

Organist - Choirmaster  
SECOND PRESBYTERIAN CHURCH

Indianapolis, Indiana 46260  
Recitals

**ROBERT L. SIMPSON**

Cathedral of St. Philip  
2744 Peachtree Road N.W.  
Atlanta, Georgia 30305

**GENE PAUL STRAYER**  
Ph.D.

Trinity United Church of Christ  
32 W. Market St., York, PA 17401  
Lancaster Theological Seminary  
555 W. James St., Lancaster, PA 17603

**BEAL THOMAS**

Church of the Ascension  
and St. Agnes  
Washington, DC

**David Wagner**  
DMA

St. Paul Church  
Grosse Pointe Farms, Michigan 48236  
WQRS-FM Detroit

**SALLY SLADE WARNER, AGO, ChM**  
Carillonneur

St. Stephen's Church, Cohasset, MA  
Phillips Academy, Andover, MA  
Recitals

**KARL MICHAEL WATSON**

TRINITY LUTHERAN CHURCH  
STATEN ISLAND

**DONALD W. WILLIAMS**

D.M.A.

Zion Lutheran Church  
Concordia College  
Ann Arbor, MI

**RONALD WYATT**

Trinity Church  
Galveston

**TODD WILSON**

F.A.G.O., ChM.

The Church of the Covenant  
11205 Euclid Avenue  
Cleveland, Ohio 44106  
Head of the Organ Dept., Cleveland Institute of Music  
Organ Faculty, Baldwin-Wallace College, Berea, Ohio

*A radio program for  
the king of instruments*

**DECEMBER**

- #9148 **Historic Holtkamps** . . . concert performances by Will Headlee at Syracuse University and David Hurd at Fisk University, Nashville, on noteworthy examples of the pioneering of American builder Walter Holtkamp, Senior.
- #9149 **Preludes to the Christmas Festival** . . . settings of Advent and Christmas melodies played by Dan Miller, James Dale, Marilyn Keiser, Douglas Major, Antoine Bouchard and others.
- #9150 **Seasonal Salutations** . . . a sampler from three centuries of organists' musical greetings for Christmas, including works by Bach, Guy Weitz and Pietro Yon.
- #9151 **Holiday Garlands** . . . sparkling and colorful arrangements of familiar tunes, with George Wright, Marilyn Mason, Aram Basmadjian, Kimberly Marshall and Kurt Luedders performing.

#9152 **An Organist's Yearbook** . . . reflections upon happenings during the past twelve months, including tributes to the late Jean Langlais and Helmut Walcha, previews of new instruments, and some resolutions for the New Year. Host's choice.



PIPEDREAMS is a weekly radio series produced by Minnesota Public Radio and broadcast over stations of the American Public Radio network. For more information, contact your local public radio station, or call APR at 612-338-5000.

**LARRY PALMER**

Professor of

Harpichord and Organ

Meadows School of the Arts

SOUTHERN METHODIST UNIVERSITY

Dallas, Texas  
75275

Musical Heritage Society recordings

**LAWRENCE**

**ROBINSON**

VIRGINIA COMMONWEALTH UNIVERSITY

RICHMOND, VIRGINIA

**DAVID SPICER**

First Church of Christ  
Wethersfield, Connecticut



House Organist  
The Bushnell Memorial  
Hartford

**GORDON YOUNG**



Mus. Doc., A.S.C.A.P.

**ORGAN BUILDERS.**

**SIMPLIFY  
YOUR ORGAN  
INSTALLATIONS**

**MULTI-ACTION  
ORGAN CONTROL**

**THE STANDARD OF THE INDUSTRY**

If you are rebuilding a large pipe organ and have a deadline to meet, simplify the task by using the **Devtronix MULTI-ACTION Computer Control Unit**

**WHAT OTHER SYSTEM CAN—**

FUNCTION AS A

- RELAY
- COMBINATION ACTION
- RECORD & PLAYBACK

IN ONE SMALL PACKAGE WITH VERY LITTLE HARDWARE OR WIRING?

**WHAT OTHER SYSTEM CAN—MAKE SPECIFICATION CHANGES IN SECONDS WITHOUT TOUCHING A SOLDERING IRON?**

**WHAT OTHER SYSTEM CAN—REQUIRE NO MAINTENANCE BECAUSE OF ITS HIGH RELIABILITY?**

**WHAT OTHER SYSTEM CAN—BE USER FRIENDLY?**

EXCELLENT WIRING AND OPERATING MANUALS

Save time and trouble with this remarkable system—write today for free brochure



1823 AVONDALE AVE.  
SACRAMENTO, CA 95825  
(916) 971-9074

DAVID HIGGS, Crystal Cathedral, Garden Grove, CA, August 9: *Prelude and Fugue in D Major*, S. 532, Bach; *Pastorale and Toccata*, Conte; *Canon in B Minor*, Schumann; *Carillon de Westminster* (with James R. Lawson, carillonneur), Vierne; *Variations on a Theme by Paganini for Pedals*, Thalben-Ball; *There is a happy land, I love thee, my Lord*, Shearing; *Suite pour Orgue*, op. 5, Duruflé.

FREDERICK HOHMAN, Methuen Memorial Hall, Methuen, MA, August 21: *Marche Slav*, Tchaikovsky/Hohman; Two pieces in D-flat: *The Seraph's Strain*, *Le Carillon*, Wolstenholme; *Grave*, Allegretto molto, Tempo di scherzo ma non troppo vivo (*Symphony V*), Vierne; *Passacaglia and Fugue on BACH*, Karg-Elert; *Carmen Fantasy*, Bizet/Lemare; *Largo (Xerxes)*, Handel/Lemare; *Fantasia Fugue*, op. 48, *Concert Fantasia and Variations on the tune 'Hanover'*, op. 4, Lemare.

MARGARET IRWIN-BRANDON, Methuen Memorial Hall, Methuen, MA, August 28: *Prelude in D Major*, *Fugue in D Minor*, Wq. 70/7, C.F.E. Bach; *Prelude and Fugue in C Minor*, Hummel; *Introduction and Passacaglia in F Minor*, op. 63, nos. 5 and 6, Reger; *Prélude et Fugue en mi majeur*, op. 99, no. 1, Saint-Saëns; *Siciliano for a High Ceremony*, Howells; *Three Preludes founded on Welsh Hymn-Tunes*, Vaughan Williams; *Variations on 'Pop goes the weasel'*, Hunter.

DAVID CLARK ISELE, with Cheryl Isele, soprano, Bienvenito Yango, clarinet, Anna Yango, violin, and Malcolm Westly, organ, Sacred Heart Church, Tampa, FL, July 31: *Prelude and Fugue in G Minor*, Buxtehude; *Graensleaves*, Purvis; *O Divine Redeemer*, Gounod; *Fantasia in G Major*, Bach; *Panis Angelicus*, Franck; *Alleluia*, Mozart; *Marche Religieuse*, Jongen; *Toccata-Finale*, Carnevali; *Were you there*, Isele; *Macarena*, Monterde/Calero; *Adagio* (Concerto in A), Mozart; *Grand Toccata*, Isele.

PAUL JESSEN, St. James United Church, Montreal, June 18: *Symphony V*, op. 42, Widor.

CHARLES KRIGBAUM, Methuen Memorial Hall, Methuen, MA, July 31: *Con-*

*certo in D Minor* op. 7, no. 4, Handel/Guilman; *Canon at the Fifth*, Parker; *Canzonette*, Ives; *Christian Union*, Donovan; *O Jesu, wie ist dein Gestalt*, S. 1094, *Machs mit mir, Gott, nach deiner Güte*, S. 957a, *Wie nach einer Wasserquelle*, S. 1119, *Wir glauben all an einen Gott*, S. 1098, *Toccata and Fugue in D Minor*, S. 538, Bach; *Minuetto (Symphonie III)*, *Méditation (Symphonie I)*, *Finale: Allegro (Symphonie II)*, Widor; *Fantasia und Fuge d-Moll*, op. 135b, Reger.

ANN LABOUNSKY, Methuen Memorial Hall, Methuen, MA, July 3: *The Winged Creatures*, Jenkins; *Amazing grace*, *Battle hymn of the republic*, *Triptyque*, Langlais; *Wondrous Love*, Barber; *Final*, Franck; *Improvisation on a submitted theme*.

THERESE LAFLAMME, with Andre Vallee, oboe, St. James United Church, Montreal, July 30: *Prelude and Fugue in B Minor*, Bach; *Liebster Jesu wir sind hier*, *O Gott du frommer Gott*, *Wachet auf ruft uns die Stimme*, Krebs; *Andante pastorale*, *Rhapsodie*, Rheinberger; *Fantasia et Fugue*, op. 135b, Reger.

JAMES MOESER, St. Michael and All Angels Church, Dallas, TX, May 15: *Fantasy in F Minor*, K. 594, Mozart; *Sonata IV in B-flat*, op. 65, Mendelssohn; *Sleepers wake, a voice is calling*, S. 645, *He who will suffer God to guide him*, S. 647, *O stay with us, Lord Jesus Christ*, S. 649, Bach; *Fantasy in F Minor*, K. 608, Mozart.

K. JOYCE MYNSTER, with Jerry Brabec, tenor, University of Nebraska, Omaha, NE, June 5: *Summertime*, Gershwin; *Unter der Linden grüne*, Sweetinck; *Pastorale and Ariary*, Roberts; *Hymne au Soleil*, op. 53, no. 3, Vierne; *I saw three clouds*, Lantz; *Wind in the pine trees*, op. 32, no. 2, Clokey; *Lied to the mountains and led to the flowers*, Peeters; *To a wild rose*, MacDowell; *Herzlich tut mich erfreuen*, op. 122, no. 4, Brahms; *Concert Variations on 'The Star Spangled Banner'*, Paine.

SYLVIE POIRIER, St. James United Church, Montreal, June 11: *Veni creator*, de Grigny; *Fantasia Choral No. 1*, Whitlock; *Le Banquet céleste*, *Dieu parmi nous*, Messiaen.

JEFF REUSING, St. James United Church, Montreal, July 9: *Voluntary in A Minor*, Stanley; *Sonata in A Major*, Mendelssohn; *Toccata, Adagio and Fugue*, Bach; *Kyrie (Messe pour les Couvents)*, Couperin; *Toccata (Symphony V)*, Widor.

REGIS ROUSSEAU, St. James United Church, Montreal, June 25: *Praeludium in E Minor*, Bruhns; *Vivace (Trio Sonata VI)*, Bach; *Suite*, Alain; *Ecos*, Evangelista; *Prelude and Fugue on BACH*, Liszt.

MARGARET SCHARF, with Warren A. Scharf, Methuen Memorial Hall, Methuen, MA, July 24: *Sonata in F Minor*, Mendelssohn; *Jesu, geh'voran*, op. 65, no. 56, Karg-Elert; *Fantasia in F Minor*, S. 608, Mozart; *Martyrs: Dialogue on a Scottish Psalm-Tune*, op. 73, Leighton; *Divertissement*, *Berceuse*, *Scherzetto*, Vierne; *Requiescat in pace*, *Toccata*, Sowerby.

LARRY SMITH, First and Central Presbyterian Church, Wilmington, DE, May 12: *Prelude and Fugue in D Major*, S. 532, *Deck yourself, my soul, with gladness*, S. 654, Bach; *Magnificat primi toni*, BuxWV 203, Buxtehude; *Concerto in B-flat*, op. 4, no. 2, Handel; *Sonata*, op. 65, no. 6, Mendelssohn; *Two Meditations*, Adler; *Toccata for Organ*, Decker.

MICKEY THOMAS TERRY, Basilica of the National Shrine of the Immaculate Conception, Washington, DC, June 23: *Prelude and Fugue in A-flat*, op. 36, *Prelude and Fugue in F Minor*, op. 7, *Trois Elevations*, op. 32, no. 1, *Toccata (Deuxième Symphonie)*, op. 26), IX. *Jesus falls for the third time*, X. *Jesus is stripped of his clothes (Le Chemin de la Croix)*, op. 29), *I am black but comely (Fifteen Pieces)*, op. 18), *Moderato*, *Allegro deciso (Evocation)*, op. 37), Dupré.

CHARLES BOYD TOMPKINS, Zion Lutheran Church, Ft. Wayne, IN, June 16: *Sonata III*, Mendelssohn; *Sonata III*, Hindemith; *Five Pieces for Flute Clock*, Haydn; *Fantasia in F Minor*, K. 608, Mozart; *Sketch in D-flat*, op. 58, no. 4, *Canonic Study in B*, op. 56, no. 6, *Sketch in F Minor*, op. 58, no. 3, Schumann; *Allein Gott in der Höh sei Ehr*, S. 663, 664, *Prelude and Fugue in D*, S. 532, Bach.

**Delaware**

DELAWARE ORGAN COMPANY, INC.  
PO Box 362  
Tonawanda, New York 14150  
(716) 692-7791

MEMBER: APOBA

**A ANDOVER**

Modern Mechanical Action  
New Organs - Restorations - Rebuilding  
P.O. Box 36, Methuen, Massachusetts 01844  
Telephone (508) 686-9600

**AUSTIN  
ORGANS**

ORGAN ARCHITECTS AND BUILDERS  
156 WOODLAND STREET, HARTFORD, CT 06105  
(203) 522-8293

**Brunzema Organs Inc.**

596 Glengarry Crescent South  
Post Office Box 219  
Fergus, Ontario • Canada  
N1M 2W8 • 519 787 0033

Telephone: (705) 435-9367

**PAUL F. MARTIN**  
Tracker Organs

R.R. #1, Mansfield, Ontario, Canada L0N 1M0

PIPE ORGAN BUILDERS • EST. 1877

**SCHOENSTEIN**  
SAN FRANCISCO

3101 20th ST., 94110 • (415) 647-5132

Tuning, Repair, Voicing  
Regulating, Early Pitch  
and Temperament

Harpsichords, Forpianos  
Sales, Rentals, Concert &  
Recording Preparation

**Robert B. Turner**  
Piano / Harpsichord Technician  
Associate of G. Jacques Way & Marc Dubois

130 Pembroke Drive  
Yonkers, NY 10710

Tel (914) 953-1815  
Fax (914) 953-0017

**A & J Reed &  
Pipe Organ Service**

ARCHIE MARCHI & JOE CORKEDALE

(914) 561-1480

36 CARTER STREET NEWBURGH, NY 12550

(212) 757-3503

**Christopher A. Ballard**

PIPE ORGAN BUILDER

NEW INSTRUMENTS  
TUNING/MAINTENANCE  
REBUILDS 205 WEST 54TH STREET  
TONAL WORK NEW YORK, N.Y. 10019

**QUIMBY PIPE ORGANS  
INCORPORATED**  
WARENSBURG, MISSOURI

P. O. Box 434 Warrensburg, MO 64093  
816/747-3066

**BELLS**

CHIME SYSTEMS • CARILLONS • ELECTRIFICATION

TOLL FREE 1-800-544-8820

**vanBergen Bellfoundries, Inc.**

**FINE ORGAN LEATHERS SINCE 1800**

**BEVINGTONS AND SONS of LONDON**

NECKINGER MILLS  
ABBEY STREET  
BERMONDSEY  
LONDON SE1 2AW

BROCHURES SENT  
ON REQUEST

**ALFRED J. BUTTLER III**

Unadulterated Restoration of  
Worthy Electro-Pneumatic Instruments

122 Huntington Street, New Brunswick, N.J. 08901  
908-828-4244

ORGAN BUILDERS  
tools and supplies

**TRACKER-TOOL  
SUPPLY CO.**

799 West Water Street  
Taunton, Mass 02780

Member APOBA (317) 637-5222

**Goulding & Wood, Inc.**

823 Massachusetts Ave. Indianapolis, IN 46204

**GEORGE BOZEMAN, JR  
AND COMPANY**  
ORGAN BUILDERS

Telephone: (603) 463-7407  
41 Raymond Road  
(Route 107)  
Deerfield, New Hampshire 03037

fine leather shoes for organists

**Organmaster Shoes**

Fast UPS Delivery

WOMEN'S, 3 Colors, Sizes 4 - 11, \$33 ppd.  
MEN'S, Black, Sizes 6 - 12, \$38 ppd.  
Sizes 12½ - 13, \$43 ppd., Sizes 14 - 16, \$48 ppd.  
Narrow, Medium and Wide widths  
CALL OR WRITE (203)-453-1973  
282 Stepstone Hill, Guilford, CT 06437

**martin ott pipe  
organ  
company  
inc.**

1353 Baur Boulevard  
St. Louis, Missouri 63132  
(314) 569-0366

# CLASSIFIED ADVERTISING

Classified Advertising Rates  
will be found below

## POSITIONS AVAILABLE

**Schantz Organ Co. is accepting applications** for an experienced reed voicer. Salary and benefits commensurate with experience. Send resume to Victor B. Schantz, c/o Schantz Organ Co., P.O. Box 156, Orrville, OH 44667.

**First Presbyterian Church, Royal Oak, MI,** seeks full-time Music Director for 2100-member church. Job includes directing 6 choir music programs. Two possibilities for starting dates are spring and fall of 1992. Salary negotiable, benefits offered. Send resume to: Charlene Gardiner, Chair Music Search Committee, 529 Hendrie Blvd., Royal Oak, MI 48067.

**Organists: Augment your income through organ sales**—send resume. Sales experience not required. Openings throughout U.S. Write: Allen Organ International Sales Headquarters, Macungie, PA 18062.

**A Midwestern organbuilder is accepting applications** for two positions in their service department. An experienced tuning and service technician is required for maintaining organs of all types. A tuning assistance position is available to a person with little experience but with keyboard knowledge and aptitude to become a professional technician through training on the job. Both positions require willingness to travel out of town. Salary commensurate with qualifications and experience. Send resume to BOX SE-2, THE DIAPASON.

**Sales/service technician. Possible opening** for a sales-oriented, qualified service technician. Excellent pay and benefits for the right individual. Foley-Baker, Inc., 1-800/621-2624.

**Jobs for Church Musicians! All major denominations.** 7,500 referrals made. Weekly mailings. Free information. Church Musicians' National Referral Service, Dept. 52, Box 36, Huntington, WV 25706-0036.

**Replies to Box Numbers should be sent to The Diapason, 380 Northwest Hwy., Des Plaines, IL 60016**

## POSITIONS WANTED

**All around organ builder, 25+ years experience,** desires responsible position with quality oriented concern. REPLY BOX DE-1, THE DIAPASON.

## MISCELLANEOUS

**Midwestern Historical Keyboard Society's 1992 annual meeting will be April 30-May 3 at Eastern Illinois University, Charleston, IL. Features: Larry Palmer, author of Harpsichord in America: a Twentieth-Century Revival, in recital, "Music of the Harpsichord Revival;" Seth Carlin, winner of maximum NEA grant enabling performance of all Schubert's sonatas in New York this season, in fortepiano Schubert recital; Edward Parmentier, well-known harpsichordist and lecturer, in presentation regarding pre-Bach German harpsichord music. Also performance of all J.S. Bach's multiple-harpsichord concertos, instrument exhibits, harpsichord-care workshop, papers, festivities, etc. All welcome. Contact MHKS, 251 Redondo Rd., Youngstown, OH 44504.**

## PIPE ORGANS WANTED

**Practice organ wanted: two-manual & pedal;** 2, 3, or 4 ranks, self-contained cabinet organ, to fit under 8' ceiling. Send information, stoplist, photo and price to BOX NV-4, THE DIAPASON.

**Wanted: Kilgen Petite Ensemble for home practice organ.** Send photo and info to BOX NV-3, THE DIAPASON.

## MISCELLANEOUS WANTED

**Wanted: player pipe organ with roll library.** Tom Grattelo, 2818 Central Avenue, Alameda, CA 94501.

## MISCELLANEOUS WANTED

**Player rolls wanted for Moller Artiste player cabinet;** send me your enquiries and price expected. John Manuel, 31095 Adams, Gibraltar, MI 48173. 313/676-8929.

**Wanted: Hammond B3 organ with Leslie cabinet.** Hagglund, 55 Seacliff Ave., Seacliff, NY 11579. 516/759-2942.

## PUBLICATIONS/ RECORDINGS

**Used organ music wanted. Send list and asking price** to P.O. Box 7351, N. Augusta, SC 29841.

**Falcinelli, The Sermon on the Mount, 28pp,** \$7.60. Telemann, Twenty Little Fugues, manuals only, 21pp, \$6.20. Mozart, Adagio and Fugue in C-minor, 16pp, \$5.20. Add \$1.50 P&H for each item. Lissett Publications, Box 904, Marlborough, MA 01752. 403/273-2192.

**Double Organ Concert. Two organs (Austin 4/80-Allen 3/79),** played together by one organist, Devon Hollingsworth. Bach, Mozart, Gigout, Sousa & others. \$12 to Devon Hollingsworth, 234 58th Place, Willowbrook, IL 60514.

**Organ Records Bought and Sold. Please send your want list or SASE (large)** for list of available recordings. Organ Record Exchange, P.O. Box 384, Burlington, IL 60109.

**The Organ Literature Foundation, world's largest supplier of organ books and recordings,** offers Catalogue Z listing 731 books, 3102 classical organ LPs, cassettes, and CDs, etc. Send \$2 or 5 international reply coupons. The Organ Literature Foundation, 45 Norfolk Rd., Braintree, MA 02184-5918, 617/848-1388.

**Videocassettes/Audio Cassettes/CD's. Classical, 2-organ, Gospel, Theatre, and Instructional,** for free catalog write to Allen Organ Co., Box 36, Macungie, PA 18062-0036, or phone 215/966-2202.

## PUBLICATIONS/ RECORDINGS

**English Cathedral Choirs and Organs. Digital stereo/ambisonic UHJ surround-sound recordings** on cassette and CD. York Minster, Canterbury Cathedral and more. By airmail at US prices. Full free catalogue from Brendan Hearne (D), York Ambisonic, P.O. Box 66, Lancaster, England LA2 6HS.

**A complete listing of all available back-numbers** of THE DIAPASON is now available. Many from the 1930s on, and some older issues may also be obtained for your personal or library collection. Send SASE to The Organ Historical Society, Box 26811, Richmond, VA 23261.

**Historic Organs of San Francisco features 20 historic pipe organs** in the San Francisco Bay area recorded in June, 1988 during the Organ Historical Society's National Convention, available as a two-cassette or two-compact disc set more than two hours long. Both formats include a 28-page booklet with histories and stoplists of organs heard. Twenty organists perform 31 works by 30 composers. Order cassettes or CD's from the OHS Catalog, Box 26811, Richmond, VA 23261 at \$22.95 plus \$1.50 shipping and handling.

**The Organ Historical Society is offering a 32-page catalog** of publications, recordings, and other items, many of which are produced by the OHS. The catalog also includes many hard-to-find popular recordings and books from other sources. Send 45¢ stamp to: OHS, Box 26811, Richmond, VA 23261.

## HARPSICHORDS

**ERIC HERZ HARPSICHORDS, est. 1954.** See our selection of finely crafted harpsichords in the German, French, and English traditions. Come play them in our showroom, or send for free catalog: 12 Howard Street, Cambridge, MA 02139. 617/868-6772.

**Harpsichords. Custom-made at reasonable price.** No-interest financing available. Steven Sorli, 1022-D Westford St., Carlisle, MA 01741. 508/369-7514.



**Berghaus Organ Company, Inc.**  
537 South 25th Avenue  
Bellwood, Illinois 60104  
708-544-4052 Fax 708-544-4058

ORGANS BY  
**Gabriel Kney**  
137 FALCON STREET,  
LONDON, ONTARIO, CANADA.  
N5W 4Z3 (519) 431-3310

**J.F. NORDLIE COMPANY**  
Organ Builders  
504 So. Charlotte Ave. Sioux Falls, SD 57103  
(605) 335-3336  
(800) 456-0834 John F. Nordlie

**TAYLOR & BOODY**  
ORGAN BUILDERS  
George K. Taylor John H. Boody  
Route 1, Box 58 B, Staunton, Virginia 24401  
Telephone: (703) 886-3583



**Bunn - Minnick Company**  
Excellence in Pipe Organ Building and Service  
513 Hartman Avenue  
Columbus, Ohio 43201  
(614) 299-7954



**LEVSEN**  
ORGAN COMPANY  
P.O. BOX 542 BUFFALO, IOWA 52728 (800) 397-1242

**ROSALES**  
MUSICIAN BUILDERS INC.  
2949 EAST LIVINGSTON STREET LOS ANGELES CALIFORNIA 90023  
(213) 262-9253

**Robert M. Turner**  
Organbuilder  
148 Homestead Street  
La Puente, CA 91744 (818) 814-1700

## CLASSIFIED ADVERTISING RATES

Regular classified advertising is single paragraph "want ad" style. First line only of each ad in bold face type.

Display classified advertisements are set entirely in bold face type with the addition of a ruled box (border) surrounding the advertisement.

Regular Classified, per word	\$ .40
Regular Classified minimum	6.00
Display Classified, per word	.60
Display Classified minimum	25.00

Additional to above charges:  
Box Service (mail forwarding) 6.00

**NOTE: Orders for classified advertising must be accompanied by payment in full for the month(s) specified. Orders will be accepted for one, two, three, four, five, or six months in advance.**

Non-subscribers wanting single copies of the issue in which their advertisement appears should include \$2.00 per issue desired with their payment.

The Diapason reserves the right to designate appropriate classification to advertisements, and to reject the insertion of advertising deemed inappropriate to this magazine.

# THE DIAPASON • 380 NORTHWEST HIGHWAY • DES PLAINES, IL 60016

insert the advertisement shown below or enclosed in the Classified Advertising section of THE DIAPASON for the following issue(s):

Category \_\_\_\_\_  Regular  Boldface

Ad Copy \_\_\_\_\_

**PAYMENT MUST ACCOMPANY ORDER**

Name \_\_\_\_\_ Phone \_\_\_\_\_  
Address \_\_\_\_\_ Total Enclosed \_\_\_\_\_  
City/State \_\_\_\_\_ Zip \_\_\_\_\_ Date Sent \_\_\_\_\_

# CLASSIFIED ADVERTISING

Classified Advertising Rates  
will be found on page 21

## HARPSICHORDS

Neupert harpsichords, clavichords, fortepianos new and used. Wally Pollee, 1955 W. John Beers Rd., Stevensville, MI 49127.

## PIPE ORGANS FOR SALE

Moller opus #5841. Parts or all. 4 ranks, 11 voices on two manuals, 2 voices in pedals. Details, call Gerry Slattery, 708/546-8656.

1925, 3-manual M.P. Moller pipe organ, opus 4266. New draw-knob console and additions in 1963. Dark oak case. 45 stops, 35 ranks, and Deagan harp with full couplers and tiling tablets. 8 generals, 6 divisionals (p/ch/sw/gt). Organ available after Easter, 1992. Buyer removes. \$25,000.00 or best offer. Offers accepted until March 1, 1992. Inquiries: Organ Committee, St. Luke's Episcopal Church, 247 West Lovell Street, Kalamazoo, MI 49007. 616/345-8553.

1934 Aeolian-Skinner organ, op. 877, 2 manuals, 15 ranks; tonal modifications and additions by Aeolian-Skinner in mid-1950s. Organ available November/December, 1992. Contact the Principia College Purchasing Office, Elmhurst, IL 62028 for more information. 618/374-5161.

Pipe organ for sale: 22 ranks, 3 manuals, pedal. Buyer to remove from private home. Unfinished. Best offer. Organ, 5524 Stonewall Rd., Little Rock, AR 72207.

7-rank Kimball divided organ; 20 stops, 2 manuals, complete with pictures and video tape of dismantling process. Good working condition. Call or write Mervyn Finley, 407 Montgomery, Decorah, IA 52101. 319/382-9040.

Replies to Box Numbers should be sent to The Diapason, 380 Northwest Hwy., Des Plaines, IL 60016

## PIPE ORGANS FOR SALE

Pflicher organ, 2 manuals, 11 ranks, available immediately. Buyer to remove. \$4,000. Contact First Baptist Church, 239 Middle Street, New Bern, NC 28563. 919/638-5691.

3-manual electro-pneumatic pipe organ; 2 divisions, Moller windchests and pipes; Swiss Meidinger silent type blower; 61 keys, 32 pedals, custom built console; 28 stops, 10 ranks, 4 extensions. Available now. Buyer to remove. More information: August Huybrechts, 1620 Singletary Drive NE, Albuquerque, NM 87112. 505/293-0464.

2/14 Moller church organ for sale. Stop tab console; 1936 vintage, excellent condition; presently in home, unmodified, and playing. Can be seen and played by appointment. Specification list available upon request. Complete organ, blower, swell shades, etc. \$5,000. James Stetts, 1732 Clarion Dr., Williamsport, PA 17701. Phone 717/323-5104.

An Otto Eberle instrument; 12 ranks, 20 years old; excellent condition. Pastor Greg Van Dunk, 414/332-3511 (Milwaukee, WI).

Austin organ opus 1868 (1934). Two expression boxes, one air box; 23 ranks including 16' open wood, 16' Gt metal diapason, full choruses. Chests prepared for 10 additional ranks; 3-manual draw-knob console fully restored. Thomas-Pierce, Inc., P.O. Box 2562, Palm Beach, FL 33480.

Two-manual, 5-rank Reuter organ, 1960. Unenclosed practice instrument. Can be seen and played. Buyer to remove. Crow, P.O. Box 548, Lawrence, KS 66044. 913/887-6359.

1953 10-rank Hillgreen-Lane; 1973 4-rank M.P. Moller; 1965 3-rank Cannarsa/Reisner; 1965 TC-1 Allen; for price and complete specification, send SASE to Virgil Cannarsa & Assoc., 335 Orchard Avenue, Altoona, PA 16602.

## PIPE ORGANS FOR SALE

Three-manual, 38-rank Austin pipe organ, opus 58 with several newer ranks including mixtures and reeds. 61-note 8' Moller metal gedeckt, 45 scale, little nicking. E.M. Skinner French Horn, 7" pressure. 602/325-1001 M.S.T. business hours, 602/795-4610 M.S.T. after 4 pm. St. Mark's Church, 3809 E. Third St., Tucson, Arizona 85716.

2-manual, 3-rank Moller, opus 965. Console, Spencer blower, Estey pipes. \$975 or best offer. Phone 614/548-5755.

Positiv, mechanical action, one rank (8' Rohrflute), foot-winded, built by well-known builder. Mahogany case/rosewood keyboard. REPLY BOX NV-2, THE DIAPASON.

20-rank, 3-manual (Kiann console, straight rail) Holtzinger organ. Very compact, great for home; 90% will fit 8' ceiling. Two small Meidinger blowers that run on 118v. single phase. Four 16' ranks, five reeds, III mix., Maas chimes. Choir and Swell chests enclosed with swell shades. Built 1961, mostly direct electric action. Write/call for ranks and stoplist. Presently installed in home, easy to remove, owner will help. Unable to box or ship. Retiring, must sell before Mar. 92. \$5000. Don Cordell, 8932 Haddon Ave., Sun Valley, CA 91352; 818/768-6370.

Tracker organ. Two-manual and pedal organ with 11 stops, 13 ranks. New instrument at an affordable price. REPLY BOX NV-1, THE DIAPASON.

Wicks, 11 ranks, 23 stops, good condition. Available early Jan. 1992. St. Andrew's Lutheran Church, San Mateo, CA. Buyer pay removal & transportation. Make offer. Contact Bob Wunderlich, 299 Beach Park Blvd., Foster City, CA 94404. 415/574-4370.

## PIPE ORGANS FOR SALE

Tracker organ. 13 stops, Janke 1979/Rosales 1986. Oak case, tin front pipes, carved pipe shades, 61/32 AGO console. Fits under 8' ceiling. Playable by appointment. Asking \$85,000.00. 213/262-9253.

2-manual Robert Morton player pipe organ. 2-manual, 4-rank plus chimes, built in 1924. 32-note pedalboard. All parts except separate console and blower fit in 7 x 9 x 9 room. In working condition. Business being sold. Buyer to remove at own expense. Best offer. Holton & Son Mortuary, 614 Locust Ave., Long Beach, CA 90802. 213/436-9679.

1906 Kimball, 3M, 20R; 10 new ranks and solid-state console added by Gundling in 1978. \$10,000 or best offer. Available summer 1992. Information and specifications available from Trinity United Church of Christ, 32 W. Market St., York, PA 17401.

1965 Aeolian-Skinner, 3 manuals, 53 stops, 67 ranks. Available May 1992. Contact: John Gibson, Director of Facilities, Owen Fine Arts Center, Room B-004, Meadows School of the Arts, Southern Methodist University, Dallas, TX 75275. 214/692-2713.

Moller, Op. 4607 (1927), 32 ranks, 1961 3-manual Moller console, 46 stopknobs. Presently in use. Buyer must remove between April 19 and May 15, 1992. Write for specs and conditions of removal. Submit reasonable bid by January 15, 1992. Address: Pipe Organ Removal, Dilworth United Methodist Church, 605 East Boulevard, Charlotte, NC 28203.

Classified Ads must be prepaid, and may be ordered for 1, 2, 3, 4, 5, or 6 months.



## ORGAN SUPPLY INDUSTRIES

A vital part of American Organ Building,  
providing quality pipe organ supplies.  
P.O. Box 8325 • Erie, PA 16505 • 814-835-2244

## R. A. Colby, Inc.

Full Line Suppliers To The Organ Builder

Box 4058, C.R.S.  
Johnson City, TN 37602  
(615) 282-4473

For Sale  
This Space  
Write for  
Advertising Rates

## KOPPEJAN Pipe Organs Inc.

48228 Yale Rd. E., Chilliwack, B.C.,  
Canada, V2P 6H4

(604) 792-1623

## STEINER-RECK Incorporated ORGANBUILDERS

415 East Woodbine Street  
Louisville, KY 40208  
(502) 634-3636

## VISSER-ROWLAND

713/688-7346  
2033 JOHANNA B  
HOUSTON 77055

Member  
International Society of Organbuilders  
Associated Pipe Organ Builders of  
America



Quality Parts and Service  
Since 1966  
SEND \$5.50 TODAY FOR OUR  
85 PAGE CATALOG

ARNDT ORGAN  
SUPPLY COMPANY  
1018 LORENZ DRIVE - P.O. BOX 129  
ANKENY, IOWA 50021  
PHONE (515) 964-1274

ANDREW A. HUNTINGTON  
PIPE ORGAN VOICER AND CONSULTANT  
35 CEDAR LAND COURT  
CROMWELL, CT. 06416  
(203) 635-4179

FLUE VOICING—TONAL FINISHING  
TONAL REVISIONS—RESTORATIONS



3165 Hill Road  
Eagleville, TN 37060  
(615) 274-6400

CUSTOM BUILDING  
&  
RESTORATIONS

## MOLLER

Since 1875

P.O. BOX 149 (301)  
HAGERSTOWN, MARYLAND 21741 733-9000

Pipe Organ Sales and Service, Inc.  
P O Box 838 • Lithonia Ga 30058 • 404-482-4845  
Serving Pipe Organs at All Types in the Southeast

Consulting Rebuilding  
Additions Annual Maintenance  
Repairs Contracts  
New Organs

## Prestant Pipe Organs, Inc.

P.O. Box 5099 San Antonio, Texas 78201

(512) 573-3437  
(512) 494-1540



Redman Organ Co.  
816 E. VICKERY BLVD.  
FORT WORTH, TX 76104  
(817) 332-2953

MEMBER INTERNATIONAL SOCIETY  
OF ORGANBUILDERS ASSOCIATED  
PIPE ORGAN BUILDERS OF AMERICA

ORGAN BUILDING/RESTORATION

## T. R. RENCH & CO.

RACINE, WIS. 53403

1405 SIXTEENTH ST. • 414/633-9566

# Known for Quality

Manufacturer of Organparts.  
OTTO HEUSS KG  
POBox 1162 6302 LICH W-Germany

## HEUSS

ORGELTEILE

# CLASSIFIED ADVERTISING

Classified Advertising Rates  
will be found on page 21

## ELECTRONIC ORGANS FOR SALE

**Rodgers 2-manual Essex 640.** Three years old. Great for home, small church, or practice. Excellent condition. AGO specs. \$7,950. 206/820-2712.

**Rodgers custom 3 manual.** Installed in 1966. Requires large room and adequate speaker area. Being replaced by larger state-of-the-art instrument. Available January, 1992. 817/692-2282.

**New Schafer & Sons model CS-2, AGO spec.,** 2 manuals and pedal, 47 stops, chimes, harp, internal/external speakers, 4-channel external reverberation, 5000-note digital recorder, \$25,000. For details send SASE to Smith Organ Co., P.O. Box 8166, Wichita, KS 67208.

## REED ORGANS

**The reed you need. Phoenix Reed Organ** Resurrection offers replacement reeds, original knobs, faces, parts. Specify requirements w/ SASE. List of organs, 2mp, etc.: \$1.00 and SASE. Box 3, Jamaica, VT 05343. 802/874-4173.

**Farrand 2-manual, 10-rank, swell and great to** pedal, swell to great, expression pedal, full organ pedal, oak case; Kinetic blower; built 1899. \$900. 214/327-3211, Dallas, TX.

## MISCELLANEOUS FOR SALE

**Used pipes and organ equipment, SASE, Lee** Organs, Box 2061, Knoxville, TN 37901

**Give the perfect holiday gift: a gift** subscription to THE DIAPASON. See coupon on page 15.

## MISCELLANEOUS FOR SALE

**Dennison 8' French Horn, used, 61 notes, 4-** 5 inch pressure, excellent condition, in trays and ready to move. \$600.00, call 201/694-3283.

**Meldinger blower with baffle box, extra quiet,** .25 HP, 5.5" WP, \$400. Wicks console 1968 A.D. \$300, modern type with all silver contacts, plug in connectors. Reservoirs, tremolos, pipes, 328 like new bounceless chest magnets (Wicks) \$2 to \$3.50 each. Swell engines (two types); swell shutters two types, one wood, one glass see through with frame; several rectifiers 15 to 50 amps. 3210 Groomtown Rd., Greensboro, NC 27407. 919/299-9871.

**3-rank ventill chest, reservoir, legs, bearers,** super chest; 4' octave wald flute 13-49, 3 sets string basses, misc. small parts. 217/525-0706 evenings.

**E.M. Skinner 16' Bourdon, 32p. 7 1/2" x 6 1/4"** I.D. \$650; E.M.S. Con. Fl. 8', 61 p. \$300; Hutchings 8' Std. Diap. \$350; Estey Tub., chests (3) 3 & 4 stops \$75 ea.; E.M.S. Res. 24 x 36 & 30 x 48 \$100 ea.; Moller console 2M mahogany, Sw 13, Gt 9, Ped 4 + couplers \$350; Spencer 1/2 HP \$175. Ed Stauff 603/891-2262 evenings.

**3-manual Austin stop key console; 3 expres-** sion shoes plus crescendo. Good condition. \$500. Thomas-Pierce, Inc., P.O. Box 2562, Palm Beach, FL 33480.

**New: K.A. manual with gold contacts, \$100.00;** New: 60 sq. yards of black acoustical cloth, \$100.00; New: relay power supply 12V - 45A, \$75.00; Used: 3M set, black keys with contacts, free pickup. H. de Wys, 43 Wayne Ave., Piscataway, NJ 08854. 908/560-8617.

**Korg MT1200 Tuner. \$275 (list \$360). Hears** A0-C8. Plays C2-B5. Shows pitch, note, octave. Can program calibration, temperament. Korg AT12 Tuner. \$155 (list \$225). Song of the Sea, 47 West St., Bar Harbor, ME 04609. 207/288-5653. Brochures.

## SERVICES/ SUPPLIES

**New Pipework, Old Pipework Repair and Res-** toration. Call or write Paul F. Byron, Pipemaker, 855 Islington Street #2, Portsmouth, NH 03801; 603/433-3124.

**Reeds—Renovation and repair of single pipes** or complete stops. Cleaning, voicing, and rescaling for improved tone and tuning. We rebuild "neo-Baroque" or "half-length" stops, and make new resonators. Voicing done in our shop or on site. All packing materials are supplied for safe transport of pipes. Herbert L. Huestis and Associates, Dept. 628, P.O. Box 34069, Seattle, WA 98124 or 3285 East 19th Ave., Vancouver, BC Canada V5M 2T4. Phone 604/432-7646; FAX 604/432-7428.

**MIDI Interface Systems for pipe and elec-** tronic organs. Play your music synthesizer from your organ keyboards using our Model "A" MIDI Interface System. RECORD-PLAYBACK your pipe organ with our Model "C" MIDI Interface System using a standard MIDI Sequencer. The least expensive, most reliable and easiest to install Record-Playback system on the market. Write for details and prices on our Model "A" and "C" MIDI systems. Devtronix Organs, Inc., 1823 Avondale Ave., Sacramento, CA 95825. 916/971-9074.

**Releathering. Burness Associates can pro-** vide all your releathering in our modern well-equipped shop. We specialize in Skinner, Casavant, and Moller pouch boards and actions. We can also provide services on the actions of other manufacturers. Burness Associates, P.O. Box 564, Montgomeryville, PA 18936. 215/368-1121.

**Full service pipeshop producing finest qual-** ity European and American style pipework. All materials. Scaling, voicing, etc. to your specs. High lead alloy our specialty. Stephen J. Russell & Co., RR3 Box 135, Chester, VT 05143. 802/869-2540.

## SERVICES/ SUPPLIES

**Austin actions recovered. Over 20 years ex-** perience. Units thoroughly tested and fully guaranteed. Manual motor, \$19.25 f.o.b. Technical assistance available. Foley-Baker, Inc., 1212 Boston Trmpt., Bolton, CT 06043. 1-800/621-2624.

**"The Pneumatic Works" Specializing in all** types of releathering. Write: 76 Ed Clark Rd., Colrain, MA 01340, or phone 413/624-3249.

**Solid State relay for pipes. Save 50% by** assembling these simple printed circuit modules to make any relay configuration required. Highest quality components supplied. Write for information: Devtronix Organs, Inc., 1823 Avondale Ave., Sacramento, CA 95825.

**Combination Action, capture type. Least ex-** pensive and most reliable system available. Modular form lets you buy only what is required. Compatible with any relay. Not a kit. Write for information: Devtronix Organs, Inc., 1823 Avondale Ave., Sacramento, CA 95825.

**Low note pedal generator for pipes. Will** supply all 32 notes at pitches and voices required. Single tuning adjustment. Power amplifiers and speakers to match the installation. Compare our low price to others. Write for information: Devtronix Organs, Inc., 1823 Avondale Ave., Sacramento, CA 95825.

**ALL REPLIES  
TO BOX NUMBERS  
that appear  
without an address  
should be sent to:  
THE DIAPASON  
380 Northwest Hwy.  
Des Plaines, IL 60016**

# Harris Precision Products *Builders of high quality Pipe Organ Components*

7047 S. Comstock Avenue, Whittier, California 90602 U.S.A. • (213) 693-3442

David C. Harris, Member: International Society of Organ Builders, American Institute of Organ Builders, Associated Pipe Organ Builders of America

REPAIRING TUNING ADDITIONS

**R. W. KURTZ ORGAN CO.**  
CONSULTANT SPECIALISTS ON PIPE ORGAN REBUILDING  
P. O. Box 32, Woodstown, N. J. 08098 • 609 / 769-2883



**W. Zimmer & Sons, inc.**  
*pipe organ builders*

Mailing Address: P. O. Box 520  
Pineville, N. C. 28134  
Telephone (704) 588-1706



**Artisan Builders**  
806 NP Ave.  
Fargo, N. Dak. 58102  
(701) 293-8964  
*Wood Organ Pipes*

**JULIAN E. BULLEY**

New Organs — Rebuilding  
Service  
**SINCE 1906**  
1376 Harvard Blvd. — Dayton, Ohio 45406  
543-276-2481

**Robert Copeland**

P.O. Box 467  
Jeannette, PA 15644  
(412) 527-6898

*Pipe Organ Repair - All Makes*

**DURST**

**PIPE ORGAN & SUPPLY COMPANY**  
813 Boones Creek Rd. • RR14, Box 40-A  
Jonesborough, TN 37659  
(615) 753-4521

Reservoirs Chests Tremolos  
Swell Engines Swell Fronts  
*Quality from the Past Competitive for the Future*



**Greenwood  
Organ Co.**

"Three Generations of Organ Building"  
CHARLOTTE, NORTH CAROLINA 28218  
P.O. Box 18254 704/334-3819

**GUZOWSKI & STEPPE**

ORGANBUILDERS INC

NEW INSTRUMENTS  
REBUILDS - ADDITIONS  
TUNING & SERVICE  
4717 NORTHEAST 12TH AVENUE  
FT LAUDERDALE, FL 33334  
(305) 491-6852

**Klug & Schumacher, Inc.**

PIPE ORGANS  
Tuning, Repairs, Rebuilds  
Additions, Relocations  
1708 Atlanta Ct.  
Lakeland, Florida 33803  
Phone (813) 687-9425

**Levis & Hitchcock, Inc.**

*Pipe Organ Builders Since 1915*  
8466-A Tyco Road  
Vienna, VA 22182  
703-734-8585

**CHARLES W. McMANIS**

Voicer & Tonal Finisher  
20 Cowles Road  
Woodbury, CT 06798



**AUSTIN ORGANS, INC.**

P.O. Box 2562  
PALM BEACH, FLORIDA 33480  
HUGH M. PIERCE (407) 833-2087



P. O. Box 364  
Bowdon, Georgia 30108

**Proscia & Associates**

Pipe Organs  
(404) 258-9450  
Michael Proscia, President



Tel. 03404-13827

*Your personal wishes  
are in good hands*

**Jacques Stinkens** 3701 VE ZEIST  
Organ pipe makers B.V. Holland

**Reuter** Preferred Pipe Organs

73 YEARS OF SUPERIOR QUALITY  
1-913-843-2622 P.O. Box 486 Lawrence, Kansas 66044  
Fax 913-843-3302 MEMBER APOBA

# Karen McFarlane

## Artists

12429 Cedar Road, Suite 5  
 Cleveland, Ohio 44106  
 (216) 721-9095/9096  
 (216) 721-9098 (FAX)



William Albright



Guy Bovet\*



Stephen Cleobury\*\*



David Craighead



Michael Farris



Gerre Hancock\*\*



Judith Hancock



Martin  
Haselbock\*



David Higgs



Clyde Holloway



Peter Hurford\*



Gunnar Idenstam\*



Marilyn Keiser



Susan Landale\*



Olivier Latry\*



Joan Lippincott



James Moeser



Thomas Murray



Peter Planyavsky\*



Simon Preston\*\*



George Ritchie



Daniel Roth\*



Larry Smith



Donald Sutherland



Frederick Swann



Ladd Thomas



Thomas Trotter\*



John Weaver



Gillian Weir\*



Todd Wilson

**Choral Conductors\*\***  
 George Guest  
 David Hill  
 Martin Neary

\* = available 1991-92